

BM-25 | PLATE BEVELING MACHINE

The BM-25 is an easy-to-use, portable, heavy-duty machine, enabling bevels up to 25 mm wide.

The beveller is equipped with powerful motor and fitted with face milling beveling head, allowing smooth operation and exceptional efficiency.

BM-25 enables milling straight edges up to 25 mm bevel width, whereas variable spindle speed facilitates optimizing cutting conditions.

Continuously adjustable milling depth and bevel angle between 0 and 90 require no tooling to change.

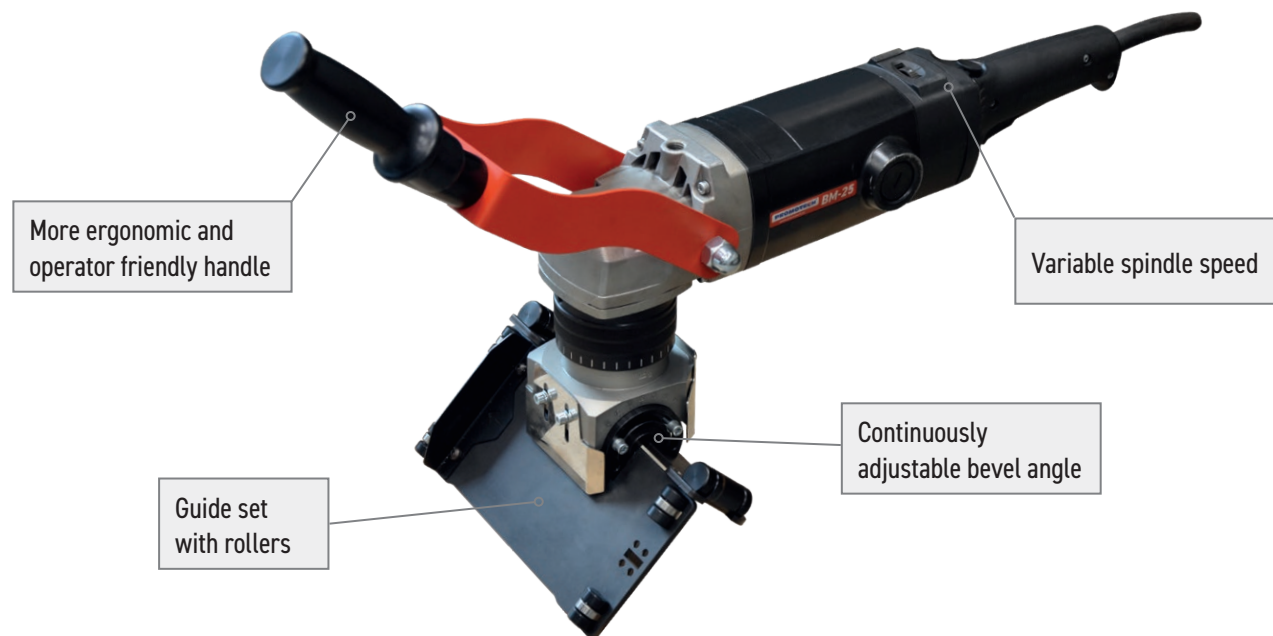

Features and benefits:

- maximum 25 mm bevel width (more than one pass could be required)
- continuously adjustable bevel angle between 0 and 90 degrees – one milling head in use only
- powerful motor with electronic speed control between 1800 – 5850 rpm to work with various materials
- a single head works with the face milling method, allowing less milling resistance and effort for the operator
- overload protection to prevent motor damage
- continuous milling depth adjustment to fully control the bevelling process
- adjustable handle and grip for comfort and ergonomics

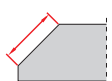

Max bevel width
25 mm



Top beveling



Bevel angles 0° - 90°
15°-75° (recommended)

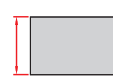

Min plate thickness
2 mm



Pipe OD beveling
min. OD 100 mm (4")
(option)

■ Comfort and ergonomics of work:

- Each user can individually adjust the position of the grip and handle
- Grip can be rotated through 360 degrees
- The handle can be tilted to the desired angle
- Adjustable grip and handle enable comfort of work for both right and left-handers and operators of different heights
- Guide set with rollers can be rotated through 360 degrees
- 2 possible positions of rollers (wide and narrow)

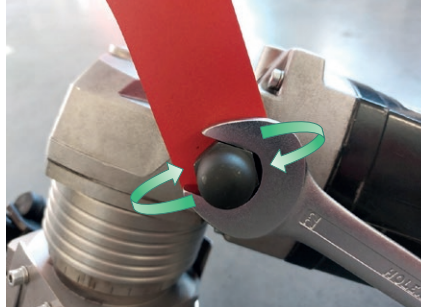
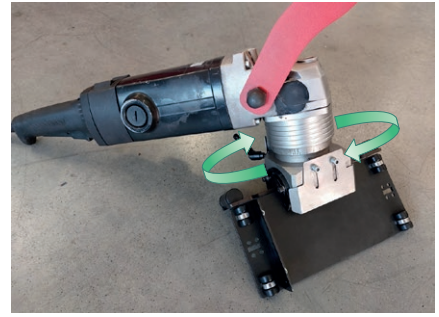

■ Continuously adjustable bevel angle between 0 and 90 degrees:

- One milling head for full range of angles
- No need for separate milling heads for specific angles
- Recommended bevel angle from 15 to 75 degrees

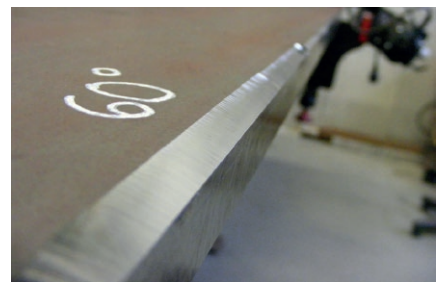

■ Bevel width up to 25 mm at 45 degrees:

- Various bevel widths are possible by means of BM-25
- The final results depend on combination of bevel angle and bevel depth



Work at 0 degree:

- Facing process to produce a flat surface such as lands/root faces

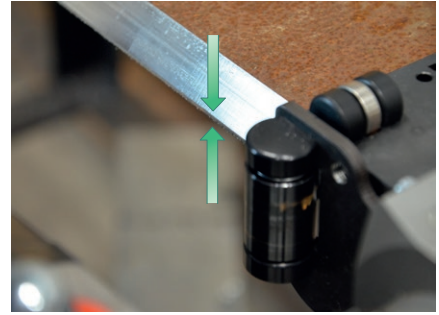
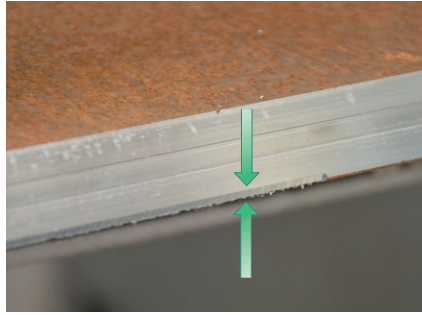
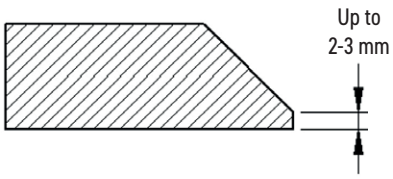

Work at 90 degrees:

- Cladding and other wear resistant coatings removal
- Lowering of the plate edge height

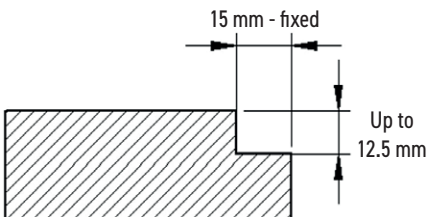

Pipe attachments for BM-25:

- Allow external beveling of pipes with a minimum diameter of 100mm (4")



BM-25 TECHNICAL SPECIFICATION

Voltage	1- 220-240 V, 50-60 Hz
Power	2200 W
Spindle speed (without load)	1800-5850 rpm
Maximum bevel width (b, Fig. 1)	25 mm (1")
Maximum depth of cut (d, Fig. 1)	12,5 mm (1/2")
Bevel angle (β , Fig. 1)	0°-90° 15°-75° (recommended)
Minimum workpiece thickness	2 mm (0.08")
Weight	12,5 kg (27 lb)
Required ambient temperature	0-40°C (34-104°F)
Product Code	UKS-0715-10-20-00-0

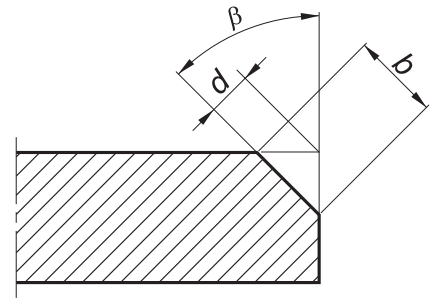
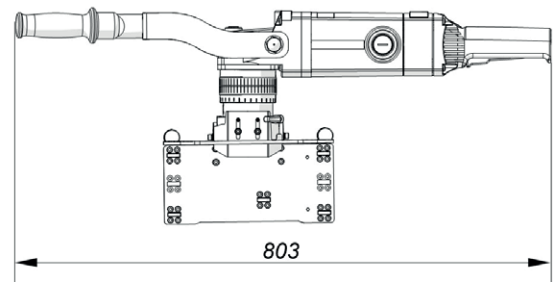
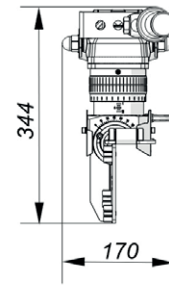

Fig. 1



Standard shipping set:

- Beveling machine incl. milling head with 5 cutting inserts
- Plastic box
- 3 chip guards (basic, 30°, 45°)
- Grease for screws (5 g, 0.17 oz)
- Drift
- 22 mm flat wrench
- 4 mm hex wrench
- 10 mm hex wrench
- Operator's manual

BM-25 uses face milling head that features:

- Less milling resistance
- Less effort for the operator
- Increased range of bevel widths that can be made manually up to 25 mm

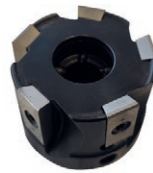

Milling head equipped with 5 cutting inserts ready for work

Accessories:

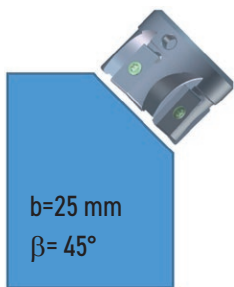

GLW-0715-19-00-00-0
Milling head



ZST-0715-23-00-00-0
Milling head for stainless steel



PLY-000756
Cutting insert
(sold 10 pcs/box)



PLY-000849
Cutting insert for stainless steel
(sold 10 pcs/box)



ZST-0715-24-00-00-0
Set of guide rollers made of stainless steel for BM-25



WKR-000577
Insert fixing screw



WKR-000592
Insert fixing screw for stainless steel

