

PROMOTECH[®]

PLATE BEVELLERS



PLATE BEVELLERS



PIPE BEVELLERS



PIPE BEVELLERS



*smart tools
for heavy tasks*

**PLATE AND PIPE
BEVELLERS**

CATALOGUE

PROMOTECH – PROFESSIONAL MANUFACTURER OF PREMIUM MACHINES FOR METALWORKING INDUSTRY

PROMOTECH is an innovation driven ISO 9001:2015 manufacturer of professional metalworking machines, welding automation equipment and industrial systems designed for structural steel fabricators, heavy machinery manufacturers, shipyards and other metal machining companies

Main product lines:

- mag drills, pneumatic drills, rail drills and hydraulic punchers
- weld preparation/portable and stationary bevellers for plates and pipes
- welding and cutting portable mechanisation equipment
- welding and cutting automated systems

Our products:

- offer solutions to reduce cost and increase productivity
- are designed and engineered for long term use in tough industrial conditions
- meet the requirements of the most demanding clients and markets worldwide
- are made in Poland according to the highest quality standards
- include top quality components
- are thoroughly tested for quality approval
- proved to be extremely reliable with a variety of practical applications in most difficult climatic environments



Mitglied im DVS – Deutscher Verband für Schweißen und verwandte Verfahren e. V.



FOLLOW US FOR UPDATE AND MORE

TABLE OF CONTENT

<i>BEVELLERS</i>	<i>PAGE</i>
BM-6 Battery	2
BM-7	3
BM-18	4
BM-18A	6
BM-20plus	8
BM-21	9
BM-25	10
BM-25S	12
BM-30 WM	14
SBM-500	16
ABM-14	18
ABM-29	20
HD CUT	23
ABM-30	24
ABM-50	26
ABM-50 DD, DD VARIO	28
PRO-2 PB	30
PRO-5 PB	32
PRO-10 PB	35
PRO-40 PBS	38
PRO-10 PB	37
PRO-40 PBS	40

BEVELING

pages
1-44



BM-6 Battery | CORDLESS COMPACT BEVELLER

Battery-powered, compact and lightweight machine produces bevels up to 6 mm wide on plates, pipes and contours.

The BM-6 Battery is also the perfect solution for rounding off radius R2, R3, R4, R5 on metal structures prior to painting to prevent rust build-up on sharp edges.

It offers greater flexibility and portability without the risk of tripping over or tangling a supply cable, and is ideal for working outdoors in remote areas where no power supply is available.

To extend the working time, BM-6 Battery is supplied with 2 rechargeable batteries.



BOOST YOUR MOBILITY WITH BATTERY POWER!
No need for power cables

Features and benefits:

- Continuous bevel width adjustment up to 6 mm at 45 degrees (30 degrees - option)
- Creates a perfect radius R2, R3, R4 or R5 in just one pass, saving time & money over conventional grinding methods
- Ideal for use in the field - no need for mains power and no cable to carry around
- Conveniently powered by an 18-volt DC battery - same CAS battery as other cordless PROMOTECH machines
- The LiHD battery ensures maximum power availability
- Single 45 degree milling head for both radius and V bevels
- Countersinking of holes with a minimum diameter of 40 mm
- Overload protection to prevent motor damage

Accessories:

- GLW-0540-08-00-00-0 Milling head 45° for cutting and radius bevels (4 inserts required)
- GLW-0540-09-00-00-0 Milling head 30° for cutting (4 inserts required)
- PLY-000391 Cutting insert for steel (sold 10 pcs/box)
- PLY-000423 Cutting insert for aluminum (sold 10 pcs/box)
- PLY-000737 Cutting insert R2 (sold 10 pcs/box)
- PLY-000738 Cutting insert R3 (sold 10 pcs/box)
- PLY-000739 Cutting insert R4 (sold 10 pcs/box)
- PLY-000740 Cutting insert R5 (sold 10 pcs/box)

Standard shipping set:

- Beveller (incl. 45° milling head w/o cutting inserts)
 - Plastic box
 - Special wrench
 - Grease for screws (5 g, 0.17 oz)
 - Battery 18 V LiHD 5.5 Ah *
 - T15 torx screwdriver
 - Operator's Manual
- * depending on the set chosen (see product codes in the table)



Battery 5.5 Ah
AKM-0738-10-00-03-0



Battery 10.0 Ah
AKM-0738-10-00-02-0



Battery charger with built-in Air-Cooled system
LDW-0738-10-00-30-0 (EU)
LDW-0738-04-00-30-0 (UK)
LDW-0738-06-00-30-0 (AUS/NZ)
LDW-0738-24-00-30-0 (USA/CND)
Charging time: ~ 41 min (5.5 Ah)
~ 74 min (10.0 Ah)

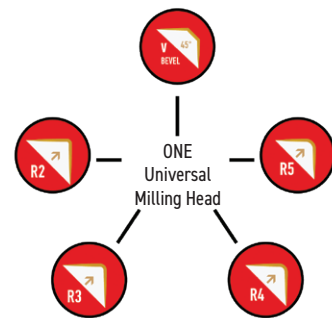

Miscellaneous:

- LDW-0738-10-00-30-0 Battery charger ASC 145 (EU)
- LDW-0738-04-00-30-0 Battery charger ASC 145 (UK)
- LDW-0738-06-00-30-0 Battery charger (AUS/NZ)
- LDW-0738-24-00-30-0 Battery charger (USA/CND)
- AKM-0738-10-00-03-0 Battery 5.5 Ah
- AKM-0738-10-00-02-0 Battery 10 Ah
- SRB-000289 Insert Screw
- RLK-0540-08-02-00-0 Guiding roller
- UST-0509-16-00-00-0 Radius positioner
- SMR-000005 Screw grease (5 g)
- NKL-0540-15-00-00-0 Anti-scratch guide sticker
- SCZ-000038 Carbon brush

Control system of battery pack:

Detection and supervised parameters:

- too low and too high voltage
- too low and too high temperature
- failure of the temperature sensor
- internal battery failure

Benefits:

- over discharge protection
- extended battery life
- high level of safety for both beveller and operator

BM-6 BATTERY TECHNICAL SPECIFICATION	
Voltage	18 V DC
Power	900 W
Spindle speed (without load)	7800 rpm
Maximum bevel width (b)	6 mm (15/64"); Fig. 1
Bevel angle (β, depends on the milling head)	45°; 30° (option); Fig.1
Minimal diameter of countersinking	40 mm (1-9/16")
Minimum workpiece thickness	4 mm (5/32")
Rounding edges	R2, R3, R4, R5; Fig. 2
Dimensions (L x W x H)	339 mm x 135 mm x 319 mm
Weight (incl. milling head)	3.7 kg (8.2 lbs)
Product code (beveller only)	UKS-0763-10-00-00-0
Product code (beveller + 2 batteries 5.5 Ah)	UKS-0763-10-00-01-0

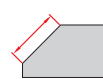
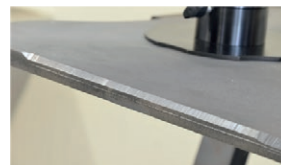
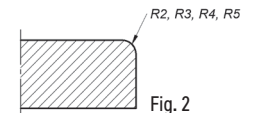
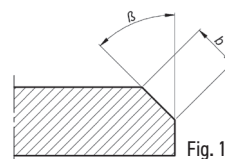

Bevel width up to 6 mm



Bevel angles 45°, 30° (option)

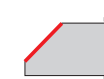

Top beveling



Bevel radius R2, R3, R4 or R5



Min plate thickness 4 mm



Pipe OD beveling



Countersinking Min. ID 40 mm



Pipe ID beveling Min. ID 40 mm



Arched edge beveling

BM-7 | COMPACT PLATE AND PIPE BEVELLER



Small and lightweight beveling machine for milling plates, pipes and contour profiles.
 Perfect solution for radius edge applying to steel sections before painting, to prevent rust build up on sharp edges.
 Quick, simple to use beveller that creates a perfect radius (R2, R3, R4 or R5) in just one pass, saving time and money over conventional grinding methods.

Features and benefits:

- Compact and lightweight beveling machine for milling plates, pipes and contour profiles
- Excellent for areas with limited access
- Continuous bevel width adjustment up to 7 mm
- Creates a perfect radius (R2, R3, R4 or R5) in just one pass, saving time and money over conventional grinding methods
- One single 45 degrees milling head for both radius and V bevels
- Quick and simple replacement of cutting inserts
- Handy, simple and easy to use beveller
- Countersinking of holes with a minimum diameter of 40 mm

Standard set includes:

- BM-7 beveller including milling head 45° w/o inserts
- Plastic box
- Special wrench
- Torx T15 screwdriver
- Screw grease (5 g)
- Operator's Manual

Accessories:

- GLW-0540-08-00-00-0 Milling head 45° for cutting and radius bevels (4 cutting inserts required)
- GLW-0540-09-00-00-0 Milling head 30° for cutting (4 cutting inserts required)
- PLY-000391 Cutting insert for steel (sold 10 pcs/box)
- PLY-000423 Cutting insert for aluminum (sold 10 pcs/box)
- PLY-000737 Cutting insert R2 (sold 10 pcs/box)
- PLY-000738 Cutting insert R3 (sold 10 pcs/box)
- PLY-000739 Cutting insert R4 (sold 10 pcs/box)
- PLY-000740 Cutting insert R5 (sold 10 pcs/box)

Spare and consumable parts:

- SRB-000289 Insert Screw
- RLK-0540-08-02-00-0 Guiding roller
- SMR-000005 Screw grease (5 g)
- NKL-0540-15-00-00-0 Anti-scratch guide sticker
- SCZ-000009 Carbon brush for 115 V / 230 V

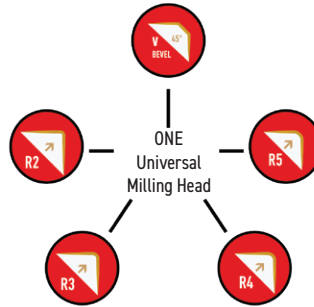

- UST-0509-16-00-00-0 Radius positioner (R2, R3, R4, R5)



Straight edge beveling with radius



Pipe beveling



Arched edge beveling with radius



Countersinking



Plate beveling

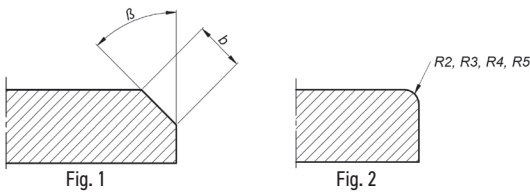

BM-7 TECHNICAL SPECIFICATION	
Power supply	1~ 110-120 V, 50-60 Hz 1~ 220-240 V, 50-60 Hz
Motor	1080 W
Spindle speed (without load)	6200 rpm
Maximum bevel width (b)	7 mm (0.28"); Fig.1
Bevel angle (β, depending on milling head)	45°; 30° (option); Fig.1
Minimal diameter of countersinking	ca 40 mm (1.6")
Rounding edges	R2, R3, R4, R5; Fig. 2
Dimensions (L x W x H)	339 mm (13.3") x 135 mm (5.3") x 320 mm (12.6")
Weight (without milling head)	6.1 kg (13.45 lbs)
Product code (220-240 VAC)	UKS-0717-10-20-00-0
Product code (110-120 VAC)	UKS-0717-10-10-00-0

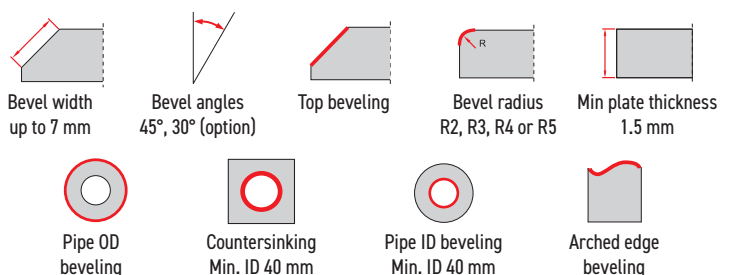



BM-18 | MULTITASK PLATE AND PIPE BEVELLER

The BM-18 is a new generation portable multitask plate and pipe beveler driven by a powerful electric motor.

It enables milling straight edges up to 18 mm bevel width, contours, holes from 40 mm in diameter and rounding off steel construction before painting or coating with radius R2, R3, R4 or R5.

New hexagonal fixing of milling heads increases beveler durability and makes replacement of the heads more convenient and user-friendly.

Variable spindle speed enables optimizing cutting conditions depending on sort of material grade incl. stainless steel, alloys, aluminum, brass or plastic.

Features & benefits:

- Powerful electric motor
- Maximum 18 mm bevel width (more than one pass could be required)
- Continuous bevel width adjustment
- New more durable milling heads with hexagonal fixing for easy replacement
- Electronic speed control between 1800-5850 rpm for use on a variety of materials
- Overload protection
- Beveling milling head is equipped with 5 pcs of 2-sided indexable cutting inserts
- Milling head for rounding is equipped with 4 pcs of 4-sided indexable inserts up to R5



Accessories	
GLW-0640-30-01-00-0	Beveling milling head 22.5° (5 cutting inserts required)
GLW-0640-30-02-00-0	Beveling milling head 30° (5 cutting inserts required)
GLW-0640-30-03-00-0	Beveling milling head 37.5° (5 cutting inserts required)
GLW-0640-30-04-00-0	Beveling milling head 45° (5 cutting inserts required)
GLW-0640-30-05-00-0	Beveling milling head 50° (5 cutting inserts required)
GLW-0640-30-06-00-0	Beveling milling head 55° (5 cutting inserts required)
GLW-0640-30-07-00-0	Beveling milling head 60° (5 cutting inserts required)
PLY-000395	Cutting insert for steel (sold 10 pcs/box)
PLY-000195	Cutting insert for aluminum (sold 10 pcs/box)
GLW-0640-30-34-00-0	Milling head for rounding (4 cutting inserts required)
PLY-000737	Cutting insert R2 (sold 10 pcs/box)
PLY-000738	Cutting insert R3 (sold 10 pcs/box)
PLY-000739	Cutting insert R4 (sold 10 pcs/box)
PLY-000740	Cutting insert R5 (sold 10 pcs/box)

Spare and consumable parts:	
SRB-000289	Insert Screw (Radius)
SRB-000290	Insert Screw (Beveling)
SMR-000005	Screw grease (5 g)
RLK-0640-99-02-00-0	Bevelling roller
RLK-0640-99-03-00-0	Radius roller
SCZ-000031	Carbon brush for 110 V
SCZ-000030	Carbon brush for 230 V
NKL-0509-05-00-00-0	Sticker against scratches (for aluminum beveling)

BM-18 TECHNICAL SPECIFICATION	
Power supply	1~ 220-240 V, 50-60 Hz 1~ 110-120 V, 50-60 Hz
Power	2200 W
Spindle speed (without load)	1800-5850 rpm
Maximum bevel width	b=18 mm (0.71", Fig. 1)
Bevel angle (depending on milling head)	$\beta = 22.5^\circ, 30^\circ, 37.5^\circ, 45^\circ, 50^\circ, 55^\circ, 60^\circ$
Minimum workpiece thickness	2 mm (0.08")
Minimal diameter of countersinking	ca 40 mm (1.57")
Rounding edges	R2, R3, R4, R5 (Fig. 2)
Dimensions (L x W x H)	585 mm (23.0") x 156 mm (6.1") x 238 mm (9.4")
Weight (without milling head)	10 kg (22 lbs)
Product code 220-240 V, 50-60 Hz	UKS-0670-10-20-00-0
Product code 110-120 V, 50-60 Hz	UKS-0670-10-10-00-0

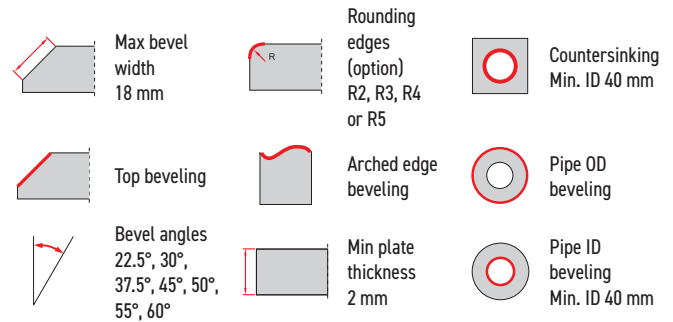

Aluminum beveling



Pipe beveling



Countersinking



Rounding off curved edges



Machining small workpieces



Lightweight and durable plastic box for convenient storage and transportation

New design of milling heads with hexagonal fixing:

- increases durability
- more convenient assembly and disassembly of the milling head
- guiding roller is integrated with each milling head
- the clearance between milling head and guiding roller is precisely factory calibrated, thus requires no adjustment by the operator



Beveling milling head

Milling head for rounding

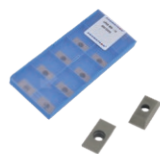

Cutting insert for steel

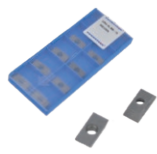

Cutting inserts for aluminum



Cutting insert R2

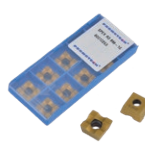

Cutting insert R3

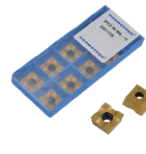

Cutting insert R4

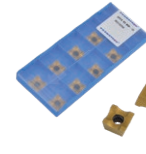

Cutting insert R5

Basic set:

- BM-18 beveling machine without accessories
- Plastic box
- 32mm flat wrench
- Allen wrench hex s=6
- Grease for screws (5 g, 0.17 oz)
- Operator's Manual



Insert Screw (Beveling)



Insert Screw (Radius)



Sticker against scratches

Pipe attachment for BM-18

Allows external beveling of pipes with a diameter of at least 150 mm (5.9") and internal beveling of pipes with a diameter of at least 110 mm (4.3").
Product code: PRW-0670-05-00-00

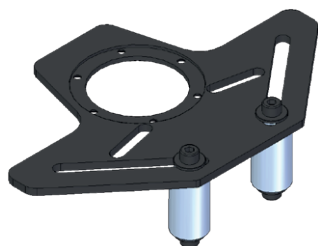

Worktable fixture for BM-18

Handy and convenient tool for machining small workpieces with cross section of at least 15x25 mm (0.6x1") and length of at least 400 mm (16"). The width of the workpiece can be up to 100 mm (4"), and height up to 65 mm (2.5"). The maximum bevel width is 14 mm (0.55").
Product Code: ZBD-0509-12-00-00



Radius insert positioner for BM-18

Useful device for easy and precise setting of radius R2, R3, R4 and R5.
Product code: UST-0509-16-00-00

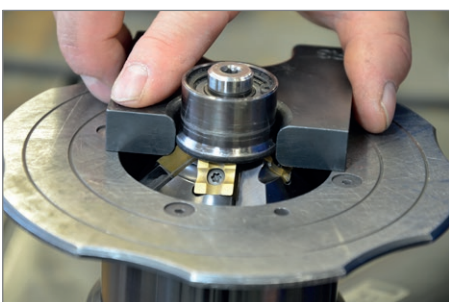



BM-18A | PNEUMATIC PLATE BEVELLER

The BM-18A is a new Promotech's plate beveller with a powerful pneumatic motor.

It enables milling straight edges up to 18 mm bevel width, contours, holes from 40 mm in diameter and rounding radius R2, R3, R4, R5.

New hexagonal fixing of milling heads increases beveller durability and makes replacement of the heads more convenient and user-friendly.

Features & benefits:

- Powerful pneumatic motor
- Maximum 18 mm bevel width (more than one pass could be required)
- New more durable milling heads with hexagonal fixing
- Easy replacement of milling heads
- Beveling milling head is equipped with 5 pcs of 2-sided indexable cutting inserts
- Milling head for rounding is equipped with 4 pcs of 4-sided indexable inserts up to R5

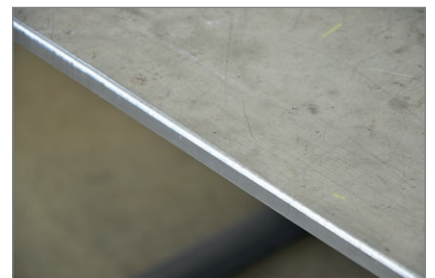
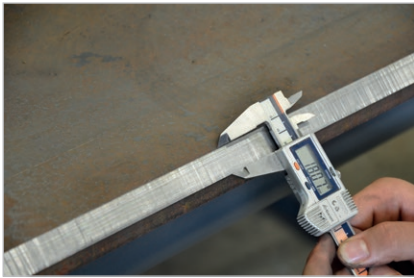

BM-18A TECHNICAL SPECIFICATION	
Spindle speed (without load)	6.000 rpm
Maximum bevel width	b=18 mm (Fig.1)
Bevel angle (depending on milling head in use)	$\beta = 22.5^\circ, 30^\circ, 37.5^\circ, 45^\circ, 50^\circ, 55^\circ, 60^\circ$ (Fig. 1)
Minimal diameter of countersinking	ca 40 mm (1.57")
Rounding edges (option)	R2, R3, R4, R5 (Fig. 2)
Minimal plate thickness	2 mm
Air requirement	6 bar (0,6MPa) (87 PSI)
Air consumption	1800 L/min, (64 CFM)
Pneumatic drive	2.800 W
Minimum required diameter of supply hose	19 mm (3/4")
Weight (without milling head)	9,3 kg
Product Code	UKS-0640-10-00-00-0

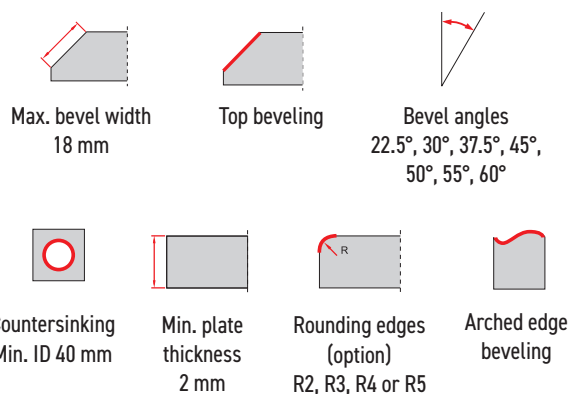

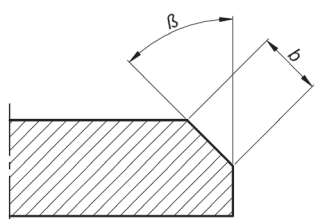

Fig. 1

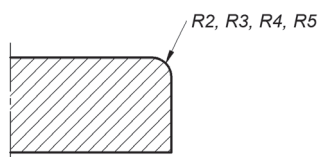
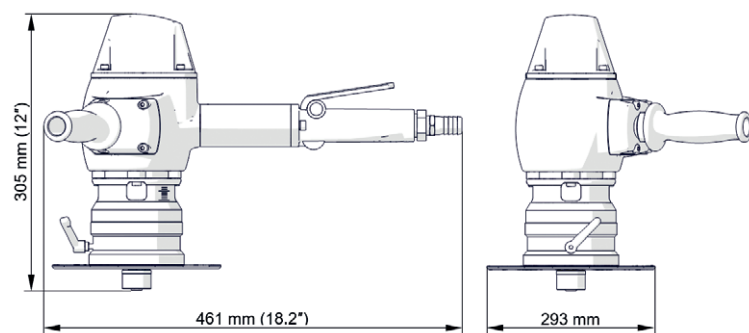

Fig. 2



New design of milling heads with hexagonal fixing:

- increases durability
- more convenient assembly and disassembly of the milling head
- guiding roller is integrated with each milling head
- the clearance between milling head and guiding roller is precisely factory calibrated, thus requires no adjustment by the operator



GLW-0640-30-02-00-0

PLY-000395

PLY-000195

Basic set:

- BM-18A beveling machine without accessories (see list below)
- Handle
- Plastic box
- Lock pin
- 32 mm flat wrench
- Allen wrench hex s=6
- Grease for mounting screws (5 g, 0.17 oz)
- Toolbox
- Operator's Manual



UST-0509-16-00-00-0

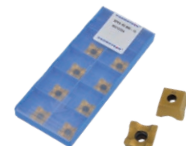

PLY-000740



NKL-0640-07-00-00-0



ZST-000021

Accessories:	
GLW-0640-30-01-00-0	Beveling milling head 22.5° (5 cutting inserts required)
GLW-0640-30-02-00-0	Beveling milling head 30° (5 cutting inserts required)
GLW-0640-30-03-00-0	Beveling milling head 37.5° (5 cutting inserts required)
GLW-0640-30-04-00-0	Beveling milling head 45° (5 cutting inserts required)
GLW-0640-30-05-00-0	Beveling milling head 50° (5 cutting inserts required)
GLW-0640-30-06-00-0	Beveling milling head 55° (5 cutting inserts required)
GLW-0640-30-07-00-0	Beveling milling head 60° (5 cutting inserts required)
PLY-000395	Cutting insert for steel (sold 10 pcs/box)
PLY-000195	Cutting insert for aluminum (sold 10 pcs/box)
GLW-0640-30-34-00-0	Milling head for rounding (4 cutting inserts required)
PLY-000737	Cutting insert R2 (sold 10 pcs/box)
PLY-000738	Cutting insert R3 (sold 10 pcs/box)
PLY-000739	Cutting insert R4 (sold 10 pcs/box)
PLY-000740	Cutting insert R5 (sold 10 pcs/box)
UST-0509-16-00-00-0	Radius insert positioner
ZST-000021	Air preparation unit

Spare and consumable parts:	
SRB-000289	Insert Screw (Radius)
SRB-000290	Insert Screw (Beveling)
SMR-000005	Screw grease (5 g)
RLK-0640-99-02-00-0	Beveling roller
RLK-0640-99-03-00-0	Radius roller
NKL-0640-07-00-00-0	Sticker against scratches (for aluminum beveling)
WBJ-000002	Lock pin





BM-20plus | PORTABLE BEVELLER

BM-20plus is an easy-to-use, portable heavy-duty machine designed for beveling steel plates and pipes prior to welding. The machine is fitted with two rotary milling heads, each holding five 4-sided indexable inserts, allowing smooth operation and exceptional efficiency.

BM-20plus has a state of the art electronic motor overload module protecting the operator, the machine and the tooling. It is equipped with guide rolls, which make it easy and light to operate.

Features and benefits:

- Portable, heavy-duty machine
- Equipped with guide rolls for easy operation
- Automatic motor overload protection
- Fitted with two milling heads for smooth and efficient operation
- Adjustable bevel angle, 15° - 60°

β	15°	30°	45°	60°
b	21 mm	20.5 mm	21 mm	20.5 mm

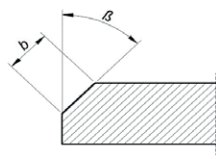

Fig. 1
Maximum bevel width depending on the angle



Plate beveling



Plate facing-off (option)



Round plate beveling (option)



Pipe beveling (option)

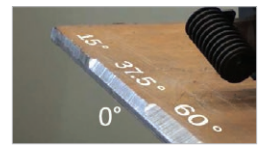

2 rotary milling heads, each holding five 4-sided indexable inserts

Optional accessories:



BM-20plus TECHNICAL SPECIFICATION	
Power supply	1~ 110-120 V, 50-60 Hz 1~ 220-240 V, 50-60 Hz
Power	1550/1600 W (for 50/60 Hz, at 220-240 V) 1700/1850 W (for 50/60 Hz, at 110-120 V) 1600 W (for 60 Hz, at 110-120 V)
Spindle speed	2780-3340 rpm (at 230 V) 2740-3290 rpm (at 115 V)
Tooling	Two milling heads with 10 square cutting inserts
Maximum bevel width (b)	21 mm (13/16") [Fig. 1]
Bevel angle (β)	15-60° [Fig. 1]; 0° (option)
Weight	22 kg (49 lbs)
Product Code (220-240 V)	UKS-0539-10-20-00-0
Product Code (110-120 V)	UKS-0539-10-10-00-0

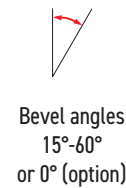
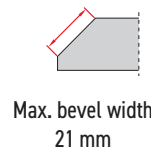

BM-21 | INDUSTRIAL PLATE & PIPE BEVELLER



This new generation portable beveling machine BM-21 is one of the best tools for machining plates and pipes prior to welding. It is a beveller developed on the basis of many years of experience with highly successful predecessor model BM-20, which for many years was on the most favored tool list for many customers worldwide.

Features and benefits:

- New single milling head equipped with 10 square inserts, that makes machining process far more efficient with little operator's effort
- Fast and easy exchange of inserts with no need for special adjustment
- Extended working range from 0 to 60 degrees with continuous angle adjustment
- Easy setting of bevel angle and bevel width
- Vibration insulation protects both the operator and electronics against vibration
- One universal guide plate for beveling both plates and pipes



Pipe beveling



Continuous angle adjustment from 0 to 60 degrees.



37%
reduced vibration



Plate facing-off



Plate beveling

BM-21 TECHNICAL SPECIFICATION	
Voltage	1~ 220-240 V, 50-60 Hz 1~ 110-120 V, 50-60 Hz
Power	1600 W (for 50 Hz) 1800 W (for 60 Hz)
Spindle speed	2780-3340 rpm (at 230 V) 2740-3290 rpm (at 115 V)
Tooling	integrated milling head with 10 square TCT inserts
Bevel angle	0-60° with continuous angle adjustment
Max bevel width	21 mm (13/16")
Weight	23 kg (51 lbs)
Product Code 220-240 V, 50-60 Hz	UKS-0461-10-20-00-0
Product Code 110-120 V, 50-60 Hz	UKS-0461-10-10-00-0

BM-21 contains anti-vibration system including special shaped gripping construction with 4 dampers, enabling more comfortable operation, minimizing unwanted vibrations.

According to manufacturer's research the new anti-vibration system reduces vibration perceptibility by 37%.



Mono block milling head, with 10 indexable inserts fixed with screws.
Product code: GLW-0461-03-00-00-0



Standard universal guide plate for beveling both plates and pipes Ø 150-300mm (6-12")



Optional guide for pipes Ø 260-600mm (10-24")
Product code: PRW-0461-22-00-00-0

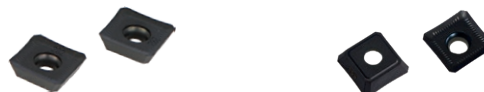

Cutting Insert (1 piece), sold 10pcs/box
Product code: PLY-000282

Cutting Insert HD (1 piece), sold 10pcs/box
Product code: PLY-000591

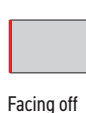
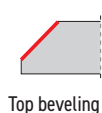
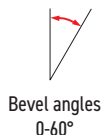
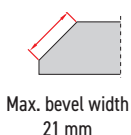



BM-25 | PLATE BEVELING MACHINE

The BM-25 is an easy-to-use, portable, heavy-duty machine, enabling bevels up to 25 mm wide.

The beveller is equipped with powerful motor and fitted with face milling beveling head, allowing smooth operation and exceptional efficiency.

BM-25 enables milling straight edges up to 25 mm bevel width, whereas variable spindle speed facilitates optimizing cutting conditions.

Continuously adjustable milling depth and bevel angle between 0 and 90 require no tooling to change.

Features & benefits:

- Maximum 25 mm bevel width (more than one pass could be required)
- Continuously adjustable bevel angle between 0 and 90 degrees – one milling head in use only
- Powerful motor with electronic speed control between 1800 –5850 rpm to work with various materials
- A single head works with the face milling method, allowing less milling resistance and effort for the operator
- Overload protection to prevent motor damage
- Continuous milling depth adjustment to fully control the beveling process
- Adjustable handle and grip for comfort and ergonomics



BM-25 uses face milling head that features:

- Less milling resistance
- Less effort for the operator
- Increased range of bevel widths that can be made manually up to 25 mm

Standard shipping set:

- Beveling machine incl. milling head with 5 cutting inserts
- Plastic box
- 3 chip guards (basic, 30°, 45°)
- Grease for screws (5 g, 0.17 oz)
- Drift
- 22 mm flat wrench
- 4 mm hex wrench
- 10 mm hex wrench
- Operator's manual

Comfort and ergonomics of work:

- Each user can individually adjust the position of the grip and handle
- Grip can be rotated through 360 degrees
- The handle can be tilted to the desired angle
- Adjustable grip and handle enable comfort of work for both right and left-handers and operators of different heights
- Guide set with rollers can be rotated through 360 degrees
- 2 possible positions of rollers (wide and narrow)

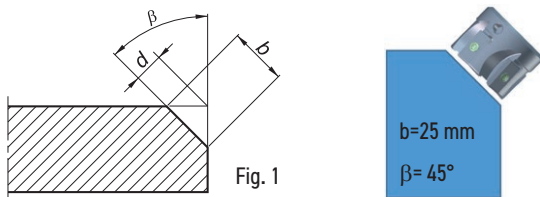
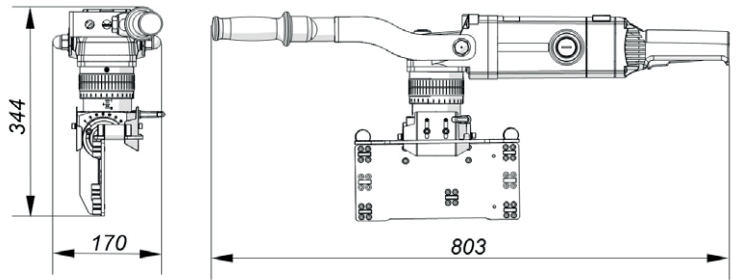

Accessories:

- GLW-0715-19-00-00-0 Milling head
- ZST-0715-23-00-00-0 Milling head for stainless steel
- Milling head equipped with 5 cutting inserts ready for work
- PLY-000756 Cutting insert (sold 10 pcs/box)
- PLY-000849 Cutting insert for stainless steel (sold 10 pcs/box)
- ZST-0715-24-00-00-0 Set of guide rollers made of stainless steel for BM-25
- WKR-000577 Insert fixing screw
- WKR-000592 Insert fixing screw for stainless steel

BM-25 TECHNICAL SPECIFICATION	
Voltage	1~ 220-240 V, 50-60 Hz
Power	2200 W
Spindle speed (without load)	1800-5850 rpm
Maximum bevel width (b, Fig. 1)	25 mm (1")
Maximum depth of cut (d, Fig. 1)	12,5 mm (1/2")
Bevel angle (β, Fig. 1)	0°-90° 15°-75° (recommended)
Minimum workpiece thickness	2 mm (0.08")
Weight	12,5 kg (27 lb)
Required ambient temperature	0-40°C (34-104°F)
Product Code	UKS-0715-10-20-00-0

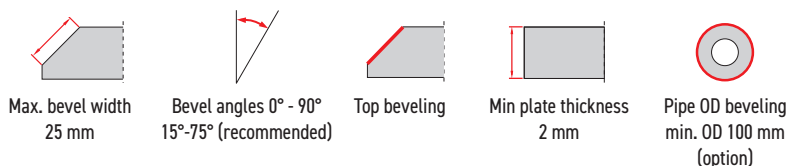

Continuously adjustable bevel angle between 0 and 90 degrees:

- One milling head for full range of angles
- No need for separate milling heads for specific angles
- Recommended bevel angle from 15 to 75 degrees



Bevel width up to 25 mm at 45 degrees:

- Various bevel widths are possible by means of BM-25
- The final results depend on combination of bevel angle and bevel depth



Work at 0 degree:

- Facing process to produce a flat surface such as lands/root faces

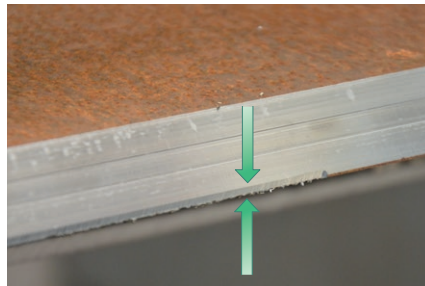
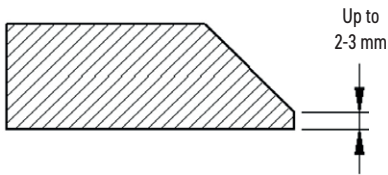

Work at 90 degrees:

- Cladding and other wear resistant coatings removal
- Lowering of the plate edge height

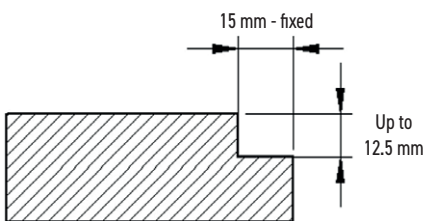

Pipe attachments for BM-25:

- Allow external beveling of pipes with a minimum diameter of 100mm (4")



ZST-0715-21-00-00-0
Set for carbon steel



ZST-0715-25-00-00-0
Set for stainless steel





BM-25S | STAINLESS STEEL PLATE BEVELLER

The BM-25S is easy-to-use, portable heavy-duty machine designed to machine stainless steel. The beveller is equipped with a powerful motor and fitted with face milling beveling head allowing smooth operation and exceptional efficiency. BM-25S allows milling of straight edges with a bevel width up to 25 mm and the variable spindle speed makes it easy to optimize cutting conditions. Continuously adjustable bevel angle between 0 and 90 degrees and milling depth for full control of the milling process. The beveller is equipped with a roller guide, which makes it easy and light to operate. All components of the guide are made of stainless steel to protect against contamination. BM-25S has got a state-of-the-art electronic motor overload module protecting the operator, the machine and the tooling.



Features & benefits:

- Contamination-free stainless steel processing
- Maximum 25 mm bevel width (more than one pass could be required)
- Continuously adjustable bevel angle between 0 and 90 degrees – one milling head in use only
- Powerful motor with electronic speed control between 1800-5850 rpm to work with various materials
- A single head works with the face milling method, allowing less milling resistance and effort for the operator
- Overload protection to prevent motor damage
- Continuous milling depth adjustment to fully control the bevelling process
- Milling head is equipped with 5 pcs of 4-sided indexable cutting inserts
- Adjustable handle and grip for comfort and ergonomics

BM-25S uses face milling head that features:

- Less milling resistance
- Less effort for the operator
- Increased range of bevel widths that can be made manually up to 25 mm

Standard shipping set:

- Beveling machine incl. milling head with 5 cutting inserts
- Plastic box
- 3 chip guards (basic, 30°, 45°)
- Grease for screws (5 g, 0.17 oz)
- Drift
- 22 mm flat wrench
- 4 mm hex wrench
- 10 mm hex wrench
- Operator's manual

Accessories:



ZST-0715-23-00-00-0
Milling head for stainless steel



PLY-000849
Cutting insert for stainless steel (sold 10 pcs/box)



WKR-000592
Insert fixing screw for stainless steel



ZST-0715-25-00-00-0
Set for external beveling of pipes made of stainless steel with a minimum diameter of 100 mm (4")

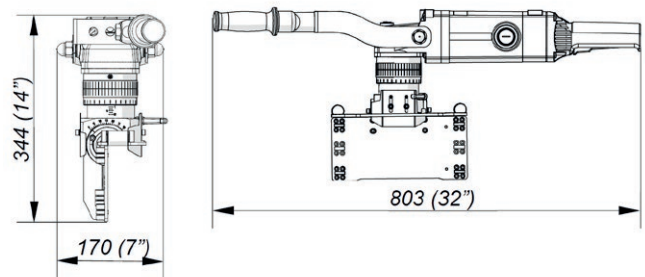
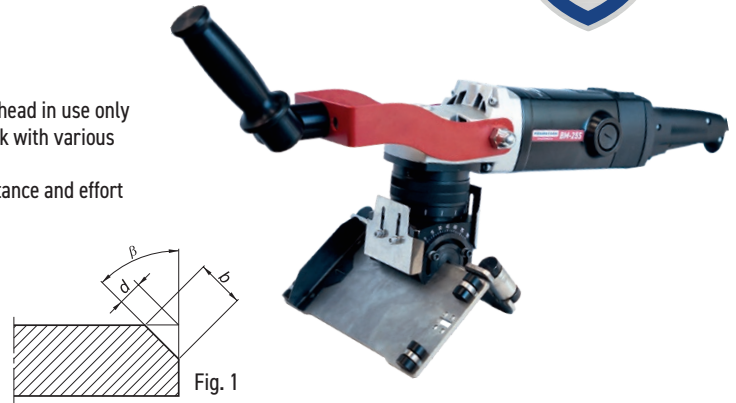
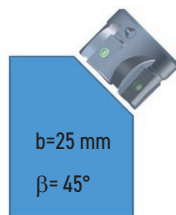

Comfort and ergonomics of work:

- Each user can individually adjust the position of the grip and handle
- Grip can be rotated through 360 degrees
- The handle can be tilted to the desired angle
- Adjustable grip and handle enable comfort of work for both right and left-handers and operators of different heights
- Guide set with rollers can be rotated through 360 degrees
- 2 possible positions of rollers (wide and narrow)

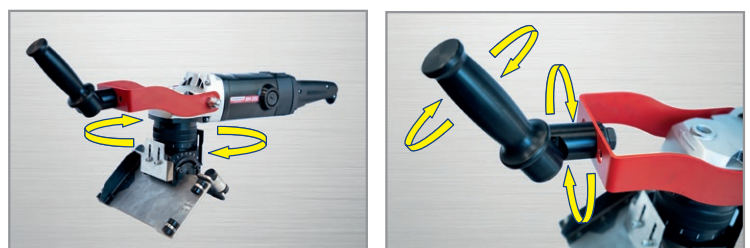

BM-25S TECHNICAL SPECIFICATION	
Voltage	1~ 110-120 V, 50-60 Hz 1~ 220-240 V, 50-60 Hz
Power	2200 W
Spindle speed (without load)	1800-5850 rpm
Maximum bevel width (b, Fig. 1)	25 mm (1")
Maximum depth of cut (d, Fig. 1)	12,5 mm (1/2")
Bevel angle (β, Fig. 1)	0°-90° 15°-75° (recommended)
Minimum workpiece thickness	2 mm (0.08")
Weight	12,5 kg (27 lb)
Product Code 110-120 V, 50-60 Hz	UKS-0825-10-10-00-0
Product Code 220-240 V, 50-60 Hz	UKS-0825-10-20-00-0

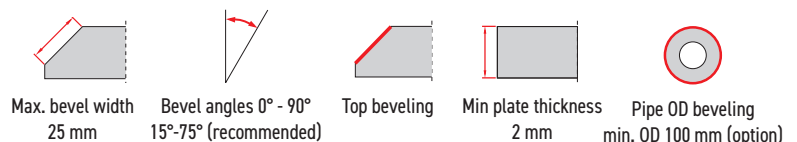

Continuously adjustable bevel angle between 0 and 90 degrees:

- One milling head for full range of angles
- No need for separate milling heads for specific angles
- Recommended bevel angle from 15 to 75 degrees

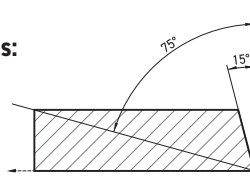

Bevel width up to 25 mm at 45 degrees:

- Various bevel widths are possible by means of BM-25
- The final results depend on combination of bevel angle and bevel depth

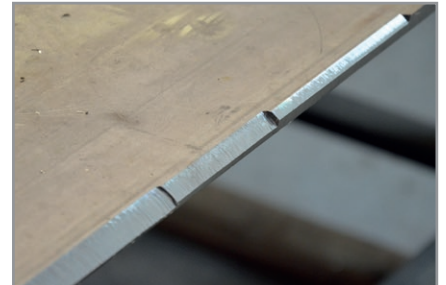

Stainless Steel machining step-by-step:

- Gradually increase the head penetration into the material to enlarge bevel width step-by-step
- Do not exceed the maximum head penetration in successive passes (see table below)
- It is recommended to remove a similar volume of stainless steel in each successive step

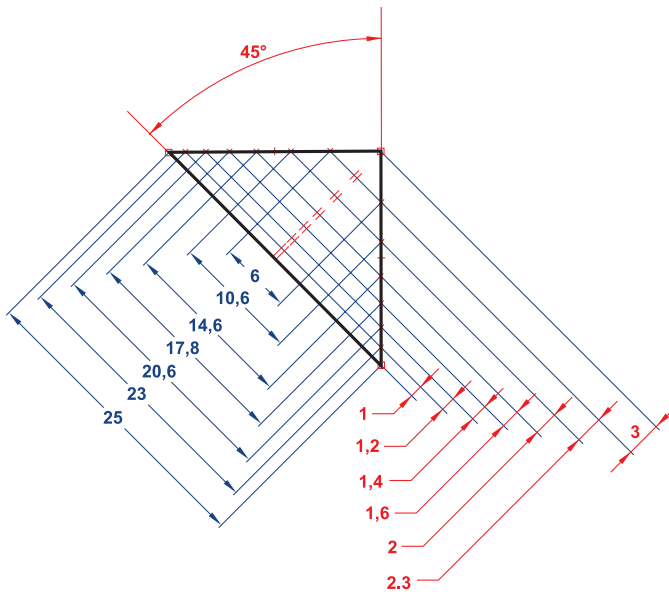

BM-25S - recommended way of working with stainless steel

Pass no.	Max. In-depth progress of milling head [mm]	Bevel width obtained [mm]
1st	3.0	6.0
2nd	2.3	10.6
3rd	2.0	14.6
4th	1.6	17.8
5th	1.4	20.6
6th	1.2	23.0
7th	1.0	25.0

Work at 0 degree:

- Facing process to produce a flat surface such as lands/root faces

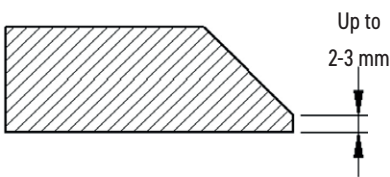

Work at 90 degrees:

- Cladding and other wear resistant coatings removal
- Lowering of the plate edge height

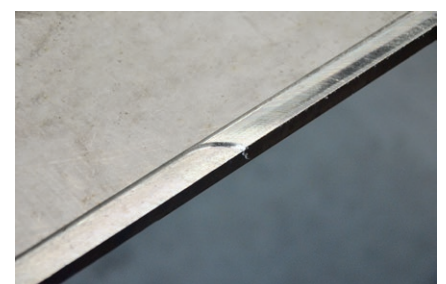
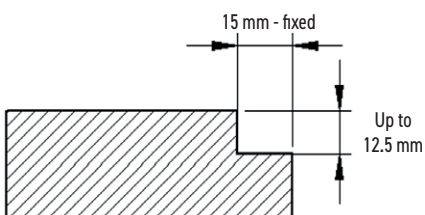



BM-30 WM | WELD MILLING MACHINE

The BM-30 WM is an easy to use, portable, heavy duty machine designed specifically for the removal of excess weld seams up to 11 mm high and 30 mm wide. It is capable of milling a weld seam down to a level and continuous surface with the rest of the parent metal in preparation for painting, coating or any other further processing. The BM-30 WM has a powerful motor with electronic speed control between 1800-5850 rpm to facilitate optimizing cutting conditions. The beveller is fitted with a rotary face milling head that ensures smooth operation and exceptional efficiency without creating any heat affected zones or distortion of the workpiece. BM-30 WM is equipped with a guide rail with a magnetic clamping system to maintain a constant position of the machine against the workpiece.

Features & benefits:

- Comfort and ergonomics of work
- Powerful electric motor
- Removal of excess weld up to 11 mm high and 30 mm wide
- Possibility of undercutting to a depth of up to 1.5 mm
- Continuous milling height adjustment
- Milling head is equipped with 5 pcs of 2-sided indexable cutting inserts
- Electronic speed control between 1800-5850 rpm
- Overload protection



BM-30 WM uses rotary face milling head that features:

- Lower milling resistance
- Less effort for the operator

Standard shipping set:

- Milling machine with rotary head incl. 5 cutting inserts
- Plastic box
- Magnetic guiding rail (500 mm long)
- Grease for screws (5 g, 0.17 oz)
- Drift
- Combination wrench 22 mm
- 10 mm hex wrench
- Operator's manual

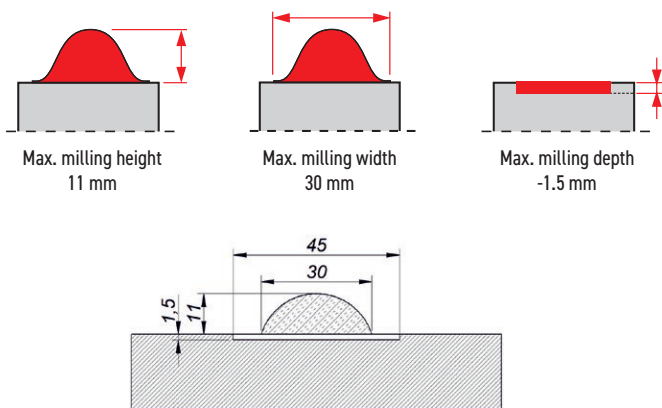

BM-30 WM TECHNICAL SPECIFICATION	
Voltage	1~ 220-240 V, 50-60 Hz
Power	2200 W
Spindle speed (without load)	1800-5850 rpm
Max. milling width	30 mm
Max. milling height	11 mm
Max. milling depth	-1.5 mm
Weight	12,5 kg (27 lb)
Product Code	FRE-0761-10-20-00-0



Accessories:

- GLW-0715-19-00-00-0 Milling head
- PLY-000756 Cutting insert (sold 10 pcs/box)
- PRW-0761-99-00-00-0 Magnetic guiding rail (500 mm long)

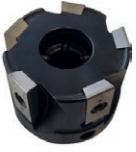

Milling head equipped with 5 cutting inserts ready for work

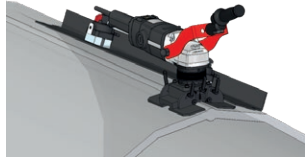
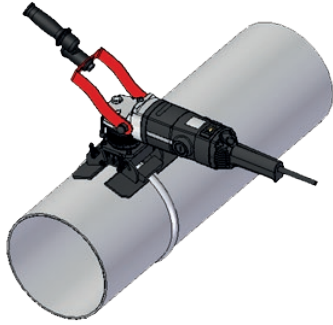

Attachment for removal of welded joints from longitudinal and circumferential surfaces (min. OD 200 mm, min. ID 400 mm) with angle adjustment from -10 to +30 degrees tanged to the cylindrical surface.

PRW-0761-11-00-00-0

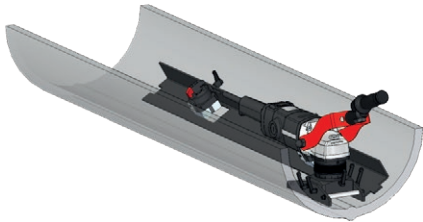

Attachment for removal of welded joints from longitudinal cylindrical surfaces (min. ID 350 mm) with tilt angle adjustment up to 15 degrees.

PRW-0761-12-00-00-0

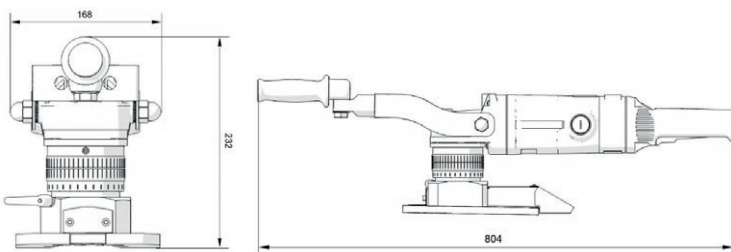



SBM-500

STATIONARY BEVELING MACHINE

Equipped with a powerful 7.500-watt motor, the stationary beveling machine is a robust and efficient solution for beveling up to 30 mm wide on different-sized workpieces up to 100 mm thick and small pipes from 50 to 150 mm in diameter.

The SBM-500 features a high-speed rotary milling head that produces a clean, milled surface without thermal distortion or a heat-affected zone.

Continuous adjustment of spindle speed and auto-feed rate makes it suitable for different types of steel and aluminum. Optional accessories expand the possible applications of the SBM-500 to deal with long workpieces, pipes 50-150 mm OD, and narrow workpieces with a minimum width of 30 mm.

Features & benefits:

- Precise setting of bevel angle from 15 up to 60 degrees and bevel width up to 30 mm
- 3D contact wheel control ensures proper workpiece alignment in relation to high-speed rotary milling head
- Variable auto-feed to bevel both ferrous and non-ferrous materials
- Cutting inserts dedicated for optimal performance on different materials
- Easy access to milling head and cutting inserts
- Overload protection to prevent motor damage
- SBM-500 streamlines workflow to maximize your production efficiency



Auxiliary tables to accommodate long workpieces

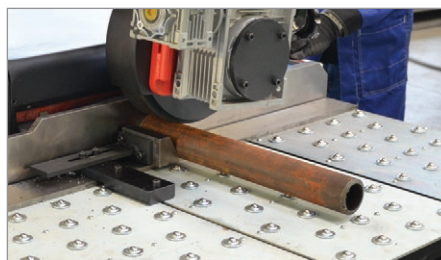

Posibility of pipe OD beveling



Attachment for narrow workpieces

SBM-500 TECHNICAL SPECIFICATION	
Voltage	3~ 400 VAC + N+PE, 50/60 Hz
Power	7500 W
Spindle speed (no load)	500 - 2920 rpm
Feed rate	up to 3.3 m/min
Feed by contact wheel	YES
Bevel angle range	15 - 60° with continuous angle adjustment
Bevel width	up to 30 mm
Milling head with 10 inserts	YES
Min. dimensions of a bar	50x150x3 mm
Max. workpiece height	up to 100 mm
Weight	845 kg
Product Code:	UKS-0573-10-00-00-0

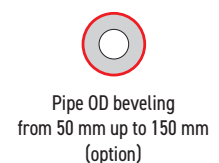
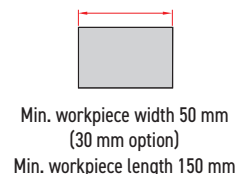
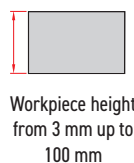
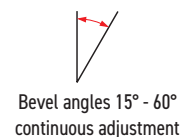
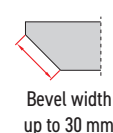
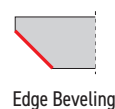

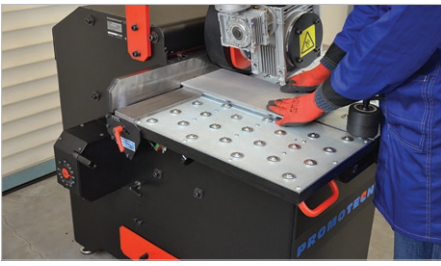

Convenient ball roller bench

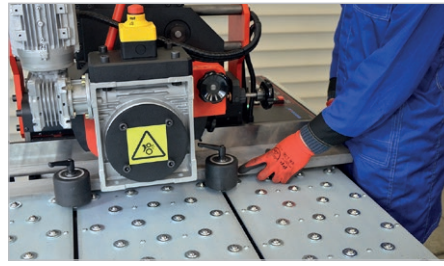

Suitable for various materials including aluminum and stainless steel



Precise bevel angle adjustment



Simple setting of bevel width



User-friendly control panel



Easy access to milling head and inserts



High quality bevel results



High quality bevel results

Standard shipping set:

- SBM-500
- Set of Tools
- Operator's Manual

Accessories:

- GLW-000030 - Milling head (10 pcs required)
- PLY-000396 - Cutting insert for steel (sold 10 pcs/box)
- PLY-000408 - Cutting insert for aluminum (sold 10 pcs/box)
- PLY-000692 - Cutting insert for stainless steel (sold 10 pcs/box)
- SRB-000418 - Insert screw
- PLY-000439 - Shim
- SRB-000417 - Shim screw
- STL-0573-37-00-00-0 - Auxiliary table for long workpieces
- PRK-0573-36-00-00-0 - Pipe beveling attachment for pipes 50-150 mm (2-6" OD)
- PRK-0573-38-00-00-0 - Narrow plate attachment

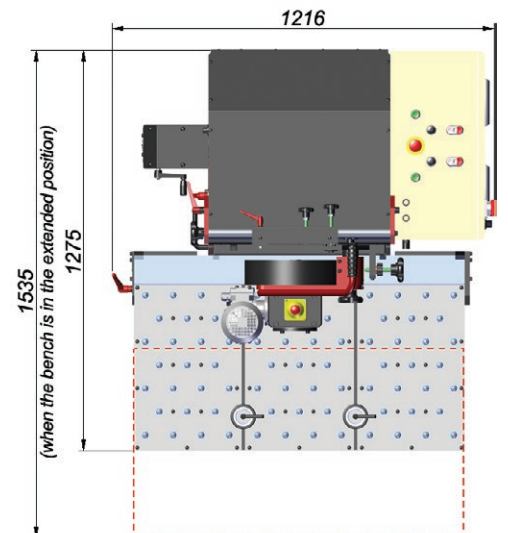

GLW-000030



PLY-000396



PLY-000408



SRB-000418



PLY-000439



SRB-000417



PRK-0573-38-00-00-0



STL-0573-37-00-00-0



ABM-14 | PLATE AND PIPE BEVELLER

ABM-14 is a beveling machine designed to mill plates and pipes made of carbon steel, alloy steel, stainless steel or aluminum alloys.

In just one single run the machine can bevel up to 12 mm (1/2") width.

Maximum bevel width is 14 mm (9/16"). Depending on materials two or more runs are needed.

The machine can bevel plates from top and bottom. Two optional ergonomic trolleys are available to make operator's work more effective and comfortable.

Using an additional vertical roller guide ABM-14 can bevel concave edges if curvature radius is 1500 mm or larger.

Features and benefits:

- Bevels both small and large pieces to cover most of the common applications for its type
- Auto feed on large plates with optional trolleys
- Beveling of lower edge in inverted position
- Standard shearing cutter for machining stainless/alloys steel
- 2 optional shearing cutters dedicated to carbon steel and to aluminum
- Reversible spindle against stuck milling tool
- Versatile and transportable on its own trolleys
- Low noise
- Possibility to bevel concave edges

Standard shipping set:

- ABM-14 beveller
- milling cutter for stainless steel
- angle variation device 30°
- cutter extraction tool
- tube beveling shaft
- tube beveling washer
- flat wrenches: 12-13 mm, 18-19 mm, 24-26 mm
- hex wrenches: 5 mm and 6 mm
- operator's Manual

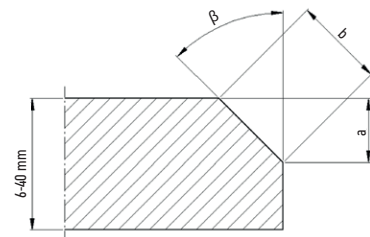

SINGLE RUN BEVELLING - CARBON STEEL						
Rm	≤ 392 MPa (57,000 psi)		392-490 MPa (57,000-71,000 psi)		490-588 MPa (71,000-85,000 psi)	
β	b [mm]	a [mm]	b [mm]	a [mm]	b [mm]	a [mm]
22.5°	12	11	10	9	8	7.5
30°	12	10	10	8.5	8	7
35°	12	9.5	10	8	8	6.5
37.5°	12	9	10	7.5	8	6
45°	12	8.5	10	7	8	5.5

SINGLE RUN BEVELLING - STAINLESS / ALLOY STEEL						
Rm	≤ 490 MPa (71,000 psi)		490-588 MPa (71,000-85,000 psi)		588-686 MPa (85,000-100,000 psi)	
β	b [mm]	a [mm]	b [mm]	a [mm]	b [mm]	a [mm]
22.5°	6	5.5	5	4.5	4.2	3.8
30°	6	5	5	4.3	4.2	3.6
35°	6	5	5	4	4.2	3.5
37.5°	6	4.5	5	4	4.2	3.3
45°	6	4	5	3.5	4.2	3

ABM-14 TECHNICAL SPECIFICATION	
Voltage	3- 400 V + PE, 50-60 Hz
Power	2200 W
Spindle speed	9 rpm (for 50 Hz); 11 rpm (for 60 Hz)
Bevel angle range (β - depending on angle device in use)	30° 22.5°, 25°, 35°, 37.5°, 45° (options)
Bevel width (b)	up to 14 mm (9/16")
Maximum bevel in one single run	12 mm (in 40 Kg/ 392 MPa carbon steel)
Minimum plate thickness	6 mm (1/4")
Maximum plate thickness	40 mm (1-9/16")
Minimum plate width	55 mm (2-3/16")
Bevel length per minute	2.6 m (8.5 ft) for 50 Hz; 3.1 m (10.2 ft) for 60 Hz
Minimum pipe ID	100 mm (4")
Weight	65 kg (144 lbs)
Product Code:	UKS-0639-10-40-00-0

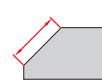

Bevel width up to 14 mm (9/16")



Bevel angles 30°, (option): 22.5°, 25°, 35°, 37.5°, 45°

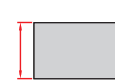

Min plate thickness 6 mm
Max plate thickness 40 mm (1-9/16")



Min plate width 55 mm (2-3/16")

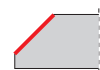

Top beveling



Bottom beveling



Pipe OD beveling
Min. ID 100 mm (4")



Round plate beveling (option)

Optional and spare accessories:



- FRZ-000586 Milling cutter for carbon steel
- FRZ-000588 Milling cutter for stainless steel
- FRZ-000587 Milling cutter for aluminum



- SCG-000002 Milling cutter extraction tool



- TRZ-000017 Tube beveling shaft
- PDK-000240 Tube beveling washer



- WOZ-0639-01-00-00-0 Basic trolley

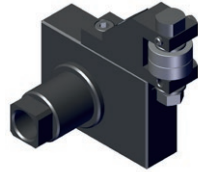

- SWK-0639-02-00-00-0 Vertical roller guide
- Min. concave curve radius 1500 mm



- MNP-0675-10-00-01-0 Machine Rotation Trolley
- One man operation
- Easy positioning for top and bottom beveling
- Height adjustment from 600 mm to 1000 mm

- PRW-000100 Angle Variation Device 22.5°
- PRW-000101 Angle Variation Device 25°
- PRW-000105 Angle Variation Device 30°
- PRW-000102 Angle Variation Device 35°
- PRW-000103 Angle Variation Device 37.5°
- PRW-000104 Angle Variation Device 45°



ABM-14 runs along a plate automatically

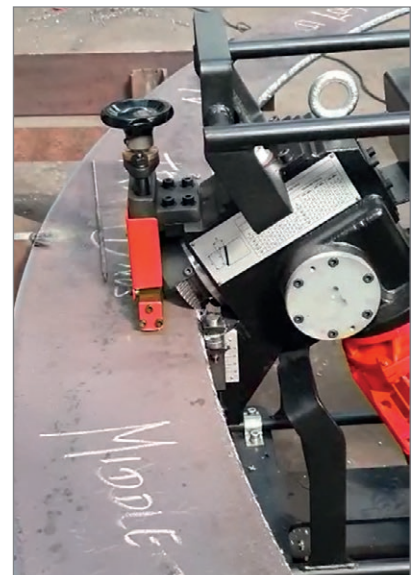



ABM-29

AUTO-FEED DOUBLE-SIDE HEAVY DUTY PORTABLE BEVELLER

In order to meet ever growing quality and efficiency requirements for heavy bevelling in metalworking industries, Promotech is introducing a new portable machine for double-sided heavy plate machining. As in the already known ABM-14 beveller the new ABM-29 machine is using a shearing method for bevelling. ABM-29 is a self-propelled heavy-duty machine which can bevel up to 20 mm width just in one pass. The ABM-29 performs double-sided bevels between 20 and 45 degrees on a variety of steels, including stainless steel and other special steel plates, without the need to turn the plate over. This beveller is equipped with an ergonomically designed trolley for transport and storage. For machining of smaller parts or pipes with ID > 150 mm, stationary operation with ABM-29 is also possible.

Features and benefits:

- Heavy-duty beveller which auto travels along an edge of a plate with speeds of up to 1.7 m/min.
- Up to 20 mm bevel width in one run and maximum 29 mm bevel width after multi passes
- Continuous milling height/bevel width adjustment
- Continuous bevel angle adjustment between 20 and 45 degrees
- Integrated trolley to facilitate top & bottom bevelling with height adjustment between 685 and 1000 mm
- Stationary operation for machining small workpieces
- Pipe machining with minimum ID 150 mm (6")
- Overload protection
- Reverse travel mode to free jammed tool
- ABM-29 is a low-noise machine

Standard shipping set:

- Beveling machine with built-in trolley
- Transport box
- Flat wrench 32-36 mm, 30-32 mm, 24-27 mm
- Shearing cutter
- Hex wrench 14 mm, 8 mm, 6 mm, 4 mm
- Operator's Manual



- One shearing cutter for machining of a variety of steel grades incl. stainless and other alloy steels

Operation in the inverted position

The trolley allows the machine to rotate 180 degrees up and down to create top and bottom bevels without having to flip the plate. It is easy one-man operation. A mechanical lock secures the machine in the upper or inverted position.

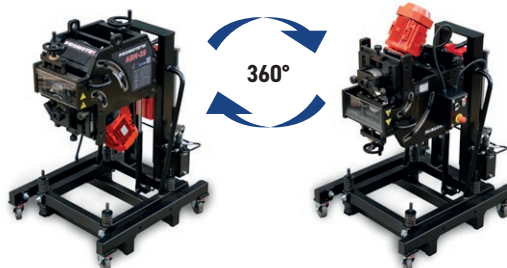

Accessories:



FRZ-000599
Single shearing cutter for various materials



ZST-0808-06-00-00-0
160 mm wheel set



SZD-0808-05-00-00-0
Chip Container

ABM-29 TECHNICAL SPECIFICATION	
Power	3000 W
Spindle speed	4 rpm (for 50 Hz); 5 rpm (for 60 Hz)
Bevel angle (β, Fig. 1)	20°-45°
Maximum bevel width (B, Fig. 1)	29 mm
Maximum bevel in one single run	20 mm
Maximum height of cut (h, Fig. 1)	14,5 mm
Minimum plate thickness	10 mm
Maximum plate thickness	40 mm (50 mm*)
Minimum plate width	80 mm
Bevel length per minute	1.7 m/min for 50 Hz; 1.9 m/min for 60 Hz
Minimum pipe ID	150 mm
Weight	540 kg
Product Code	UKS-0808-10-40-00-00-0

* for 50 mm thick plate, the minimum bevel width is 15 mm.

Possible types of bevels:

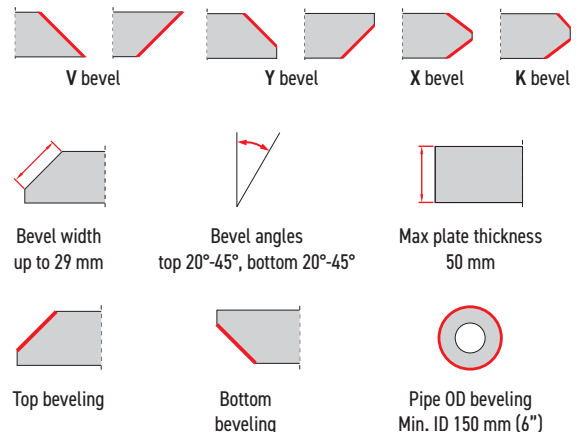

Bevel width up to 29 mm at 45 degrees

- Various bevel widths (B) are possible by means of ABM-29
- The final results depend on combination of bevel angle (β) and bevel height (h)

Single run beveling up to 20 mm width

Depending on sort of material up to 20 mm bevel width is possible with ABM-29 in a single run.

CARBON STEELS	SINGLE RUN BEVELLING TABLE						
	β	20°	25°	30°	35°	37.5°	45°
Rm \leq 392 Mpa (57,000 psi)	B	20	20	20	20	20	20
	h	19	18	17.5	16.5	16	14
Rm = 392-490 Mpa (57,000-71,000 psi)	B	16	16	16	16	16	16
	h	15	14.5	14	13	12.5	11.5
Rm = 490-588 Mpa (71,000-85,000 psi)	B	13	13	13	13	13	13
	h	12.5	12	11	10.5	10	9

STAINLESS - ALLOY STEELS	SINGLE RUN BEVELLING TABLE						
	β	20°	25°	30°	35°	37.5°	45°
Rm \leq 490 Mpa (71,000 psi)	B	9.5	9.5	9.5	9.5	9.5	9.5
	h	9	8.5	8	8	7.5	6.5
Rm = 490-588 Mpa (71,000-85,000 psi)	B	8	8	8	8	8	8
	h	7.5	7.5	7	6.5	6.5	5.5
Rm = 588-686 Mpa (85,000-100,000 psi)	B	7	7	7	7	7	7
	h	6.5	6.5	6	6	5.5	5

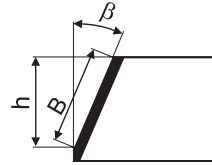
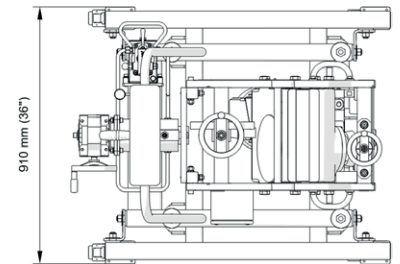
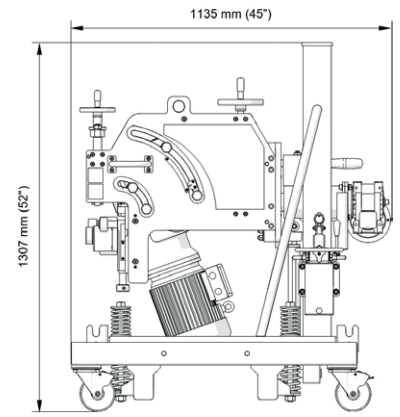
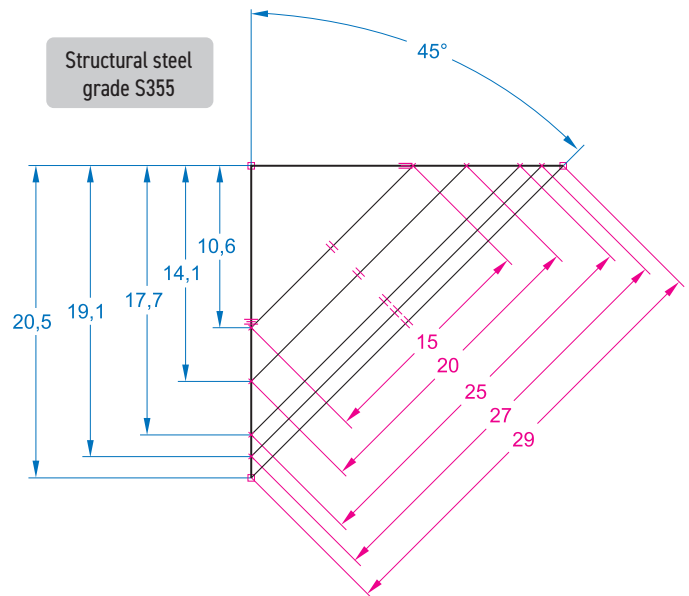
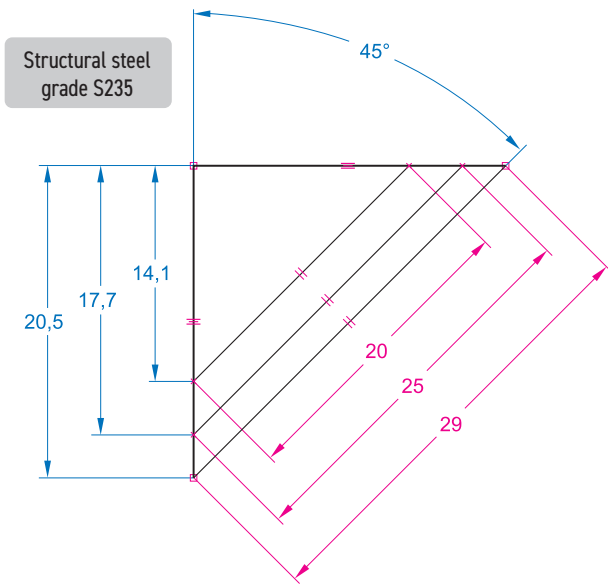

Fig. 1



Machining step-by-step

A maximum bevel width of 29 mm can be achieved in multiple passes by progressively increasing the head penetration into the material. The number of passes depends on the grade of material.



Precise adjustment of the process parameters: bevel angle, bevel depth and material thickness



Machining thick plate

Automatic feed allows ABM-29 to travel along the top and bottom edges of the plate.

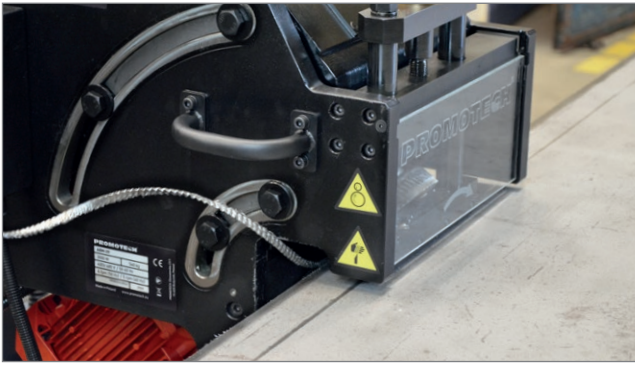

Hydraulic height adjustment

Built-in ergonomic trolley features a hydraulic height adjustment from 685 to 1000 mm. Dedicated transportation trolley locks, stiffen the machine for stationary work.

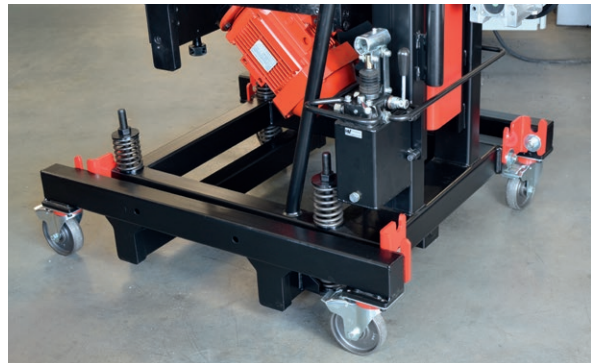

Machining longitudinal workpieces

Stationary operation is possible for machining smaller workpieces.

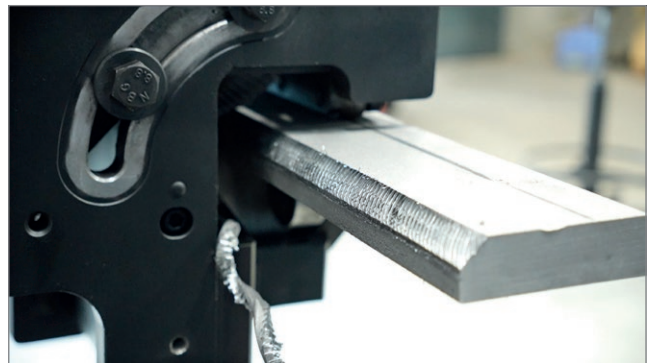

Machining pipes

ABM-29 can also bevel pipes with ID bigger than 150 mm (6").

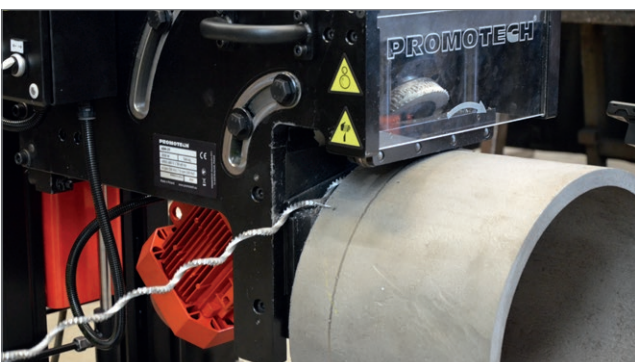

HD-CUT | COOLANT FAMILY

HD-CUT Spray - tapping, drilling and machining multi-position spray

Features and benefits:

- multi-position spray for drilling, tapping and beveling
- recommended especially for out of position works
- for hard-to-machine metals such as acid resistant or stainless steel
- provides strong and efficient protection of tools, pieces and machineries against corrosion
- water based fluid made of vegetal polymer having outstanding lubricating properties
- ready-to-use (not need to be diluted)
- free from any petroleum-based solvent
- less fumes and smell in comparison to usual products
- nonflammable
- bio-degradable lubricant
- white foaming gel
- no odour
- aerosol 650 ml / net volume 400 ml
- product code: PRE-0440-41-00-00-0



HD-CUT OIL 1 - tapping, drilling and machining fluid

Features and benefits:

- extreme pressure full oil for cutting, boring, beveling, high thickness stamping, punching, works on stainless steels all nature, threading, machining, precision and high thickness boring, drawing and profiling of all high thicknesses kinds of steels
- complex oily composition for all operations on hard-to-machine metals such as acid resistant or stainless steel, where seizing and wear quickly happen
- builds high superficial tension film to extend the life of tools and reduce their replacement interval
- significantly facilitates machining and increases its precision
- excellent product for manual working
- deposition on the tools with a brush or with an oil-can
- easy to remove using standard methods
- thick dark oil
- weight 0.5 kg or 1.0 kg or 5.0 kg
- product codes:
 OLJ-0505-09-00-00-0 (0.5 kg)
 OLJ-0505-10-00-00-0 (1.0 kg)
 OLJ-0505-11-00-00-0 (5.0 kg)



HD-CLEAN SPRAY

Features and benefits:

- perfect industrial cleaner for metal machining
- provides elimination of greases, oils, sludge and other chemical or petroleum based fluids
- perfectly suitable for all degreasing operations on all kinds of mechanical parts
- non-flammable
- biodegradable
- aerosol 650 ml / net volume 400 ml
- product code: ZMY-0440-40-00-00-0



HD-CUT BIO - concentrated micro emulsion for various machining applications

Features and benefits:

- concentrated ecofriendly micro emulsion for various machining and shavings removal operations
- suitable for coolant systems for e.g. drills, bandsaws or CNC machines
- provides effective protection against corrosion for parts, tools, and machines
- to be diluted with water
- recommended mix ratio of 25-30 parts water to 1 part concentrate
- reduce consumption dramatically compared to usual emulsions
- formulated with high molecular weight based-polyester and high viscosity index allowing a high thermal stability and outstanding lubricant qualities
- high flash point reducing fumes
- bio-degradable
- amber-colored liquid (milky aspect at 5% dilution)
- light smell
- net volume 1000 ml
- product code: CHL-0440-42-00-00-0

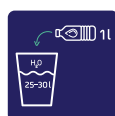



ABM-30

AUTO TRAVEL TRACKLESS BEVELLER

The ABM-30 portable beveling machine performs auto travel beveling on steel plates on top, face and bottom edges.

The beveller needs no track to move along steel plate to produce accurate high-quality double-side bevels without thermal distortion or creation of heat affected zone on plate thickness range 8-60 mm.

The ABM-30 features an infinitely adjustable bevel angle between -70 and +70 degrees and is capable of producing bevels up to 30 mm wide.

It also allows for facing in both directions with the milling head depth of 1 mm.

Features and benefits:

- 4-wheel drive eliminates a need for guide track
- Self-propelled machine for consistent bevel geometry from edge-to-edge
- Control panel indicates current work mode and gives safety and diagnostic information
- Capable of producing bevels up to 30 mm wide
- Infinitely adjustable bevel angle between -70 and +70 degrees is quick and user-friendly
- Variable spindle speed
- Produces double-side bevels without having to flip the plate enhancing safety and reducing material handling time and expense
- Feedback-controlled overload system to prevent motor damage
- Semi-automatic drive stop at plate end
- Plate thickness up to 60 mm



Top beveling



Bottom beveling



Facing-off

ABM-30 TECHNICAL SPECIFICATION

Voltage	1~200-240 V, 50/60 Hz 1~110-120 V, 50/60 Hz
Power	2200 W
Spindle rotational speed (without load)	1800-5850 rpm
Feed speed	0-2 m/min (0-6.5 ft/min)
Bevel angle (β, Fig. 1)	From -70° to 70°
Maximum bevel width (b, Fig. 1)	30 mm (1.18")
Sheet thickness	8-60 mm (0.3-2.3")
Required ambient temperature	5-40°C
Weight	43 kg (94.8 lbs)
Product Code 220-240 V, 50-60 Hz	UKS-0690-10-20-00-0
Product Code 110-120 V, 50-60 Hz	UKS-0690-10-10-00-0

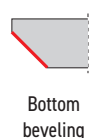
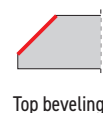
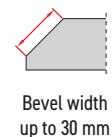
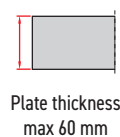

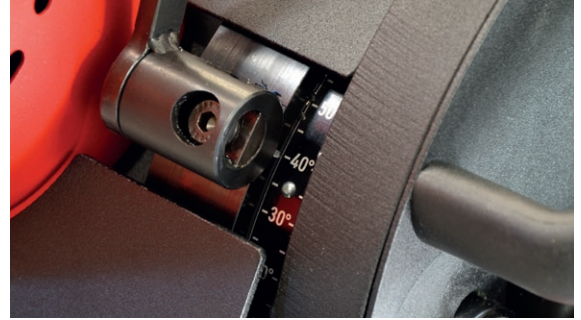

Precise bevel angle setting

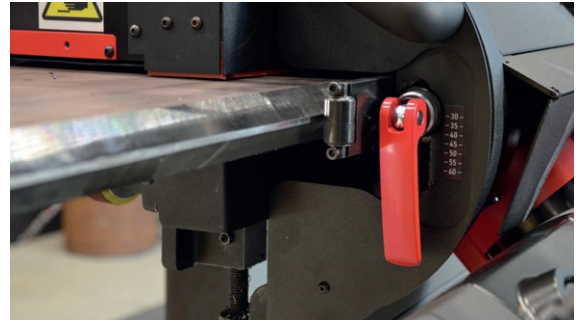

Convenient adjustment to plate thickness



Innovative and ergonomic bevel angle adjustment system with release lever requires no additional tools

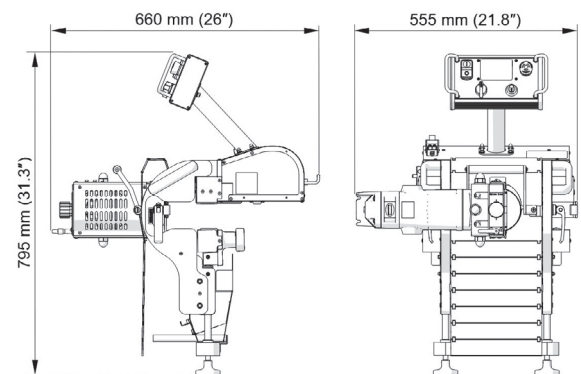

Control panel

- Feed direction indication
- Material detection
- Bar graph for motor load illustration
- Visual warning signals

β	b
0°	30 mm (1.18")
15°	30 mm (1.18")
37.5°	30.5 mm (1.2")
45°	30 mm (1.18")
60°	30 mm (1.18")
70°	31 mm (1.22")

Shipping set:

- Beveling machine (with a milling head and 5 cutting inserts)
- Tool box
- Drift
- 10 mm hex wrench
- 3 mm hex wrench
- 8 mm combination wrench
- Grease for screws Molykote 1000 (5 g, 0.17 oz)
- Operator's Manual

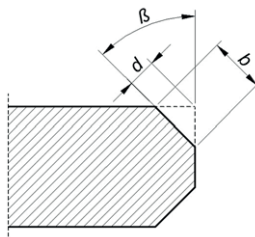

Accessories:



GLW-0715-19-00-00-0
Milling head

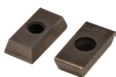

PLY-000756
Cutting insert
(sold 10 pcs/box)



WKR-000577
Insert fixing screw



ZST-0715-23-00-00-0
Milling head for
stainless steel



PLY-000849
Cutting insert for
stainless steel (sold
10 pcs/box)



WKR-000592
Insert fixing screw for
stainless steel

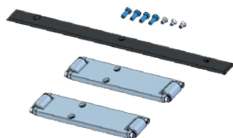

ZST-0690-16-00-00-0
Set for stainless steel for
ABM-30



WOZ-0690-20-00-00-0
Screw type transportation and
storage trolley with stepless
height adjustment



WOZ-0690-30-00-00-0
Column type transport and
storage trolley with adjustable
height in 15 mm increments



ABM-50 | AUTO-FEED DOUBLE-SIDED BEVELLER

ABM-50 produces accurate high-quality double-sided bevels without thermal distortion or creation of heat affected zone on plate thickness range 8-80 mm (5/16" - 3 1/8") using a purpose designed milling head with eight 4-sided indexable cutting inserts.

Continuously adjustable bevel angle between 15 and 60 degrees (for both top and bottom beveling) requires no tooling to change.

The operator can easily adjust and monitor the following parameters:

- bevel angle
- bevel width
- bevel height
- depth of cut
- spindle speed
- feed rate
- spindle load

Features & benefits:

- Auto-feed portable beveling
- Real-time measurement and on-screen display of exact bevel geometry and cutting parameters
- Bevel width up to 50 mm (2") at 45 degrees
- 180° inversion allows for creation of a double-sided bevel – no need to rotate or flip heavy material reduces material handling costs and improves shop safety
- Variable spindle speed for work on a variety of steel grades and thicknesses
- Versatile and transportable on its own trolley
- Equipped with milling head including 8 replaceable inserts
- Feedback-controlled overload system

The ABM-50 features an unique remote control panel with LCD display that shows exact bevel geometry and enables precise adjustment of spindle speed as well as feed speed to optimize them depending on material grade.

The precise bevel geometry can be achieved thanks to real-time measurement and live on-screen readings.



Hundreds of ABM-50 machines already installed on all continents!

Precise bevel width

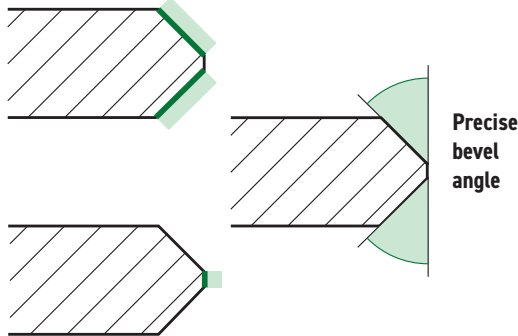

Precise bevel angle

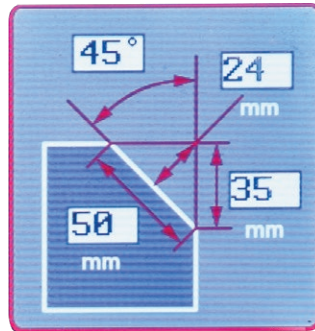

Precise bevel land



ABM-50 TECHNICAL SPECIFICATION	
Voltage	3- 400 V + PE, 50/60 Hz 3- 480 V + PE, 50/60 Hz
Power	6.5 kW
Spindle speed (no load)	300-800 rpm
Feed speed	0-1.2 m/min (47"/min)
Bevel angle (β , Fig. 1)	15-60°
Maximum bevel width (b, Fig. 1)	50 mm (2")
Maximum depth of cut (d, Fig. 1) allowed per single pass	6 mm (1/4")
Plate thickness	8-80 mm (5/16"-3 1/8")
Required ambient temperature	0-40 °C (34-104°F)
Weight	320 kg (700 lbs)
Product Code:	UKS-0627-10-40-00-0

β	b
15°	66 mm (2 5/8")
30°	52 mm (2")
45°	50 mm (2")
60°	51 mm (2")

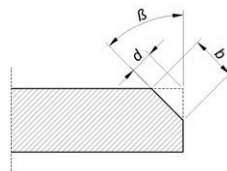
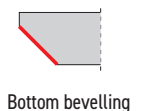
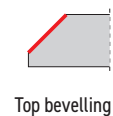
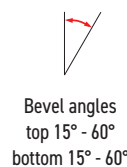
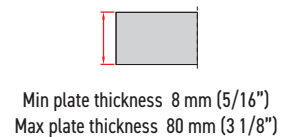
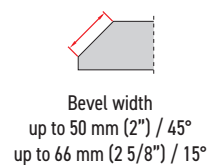
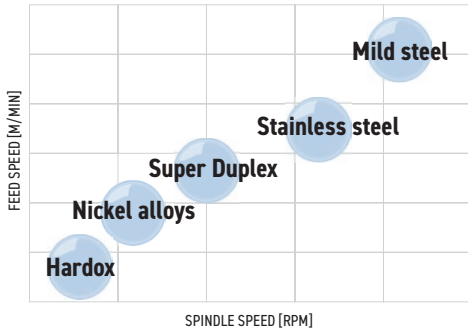

Fig. 1



- Precise adjustment of spindle speed and feed rate to optimize cutting conditions depending on material grade including stainless steel, duplex, alloys, hardox and many others.



- ABM-50 can perform beveling along steel plate's edge eliminating hard physical work of the operator. The maximum bevel at 45 degrees is up to 50 mm (2").



- 180° inversion of ABM-50 enables a double-sided bevel eliminating the need to turn over long and heavy plates.



- ABM-50 can be used without a trolley if needed e.g. when floor surface is uneven significantly.



- ABM-50 proved to be reliable and efficient beveller in most demanding working conditions including high temperature and humidity.



Standard shipping set:

- Beveling machine with milling head and 8 cutting inserts
- Wooden box with base and mounting brackets
- Special wrench
- 10 mm T-handle hex wrench with ball tip
- 3,5 mm hex wrench
- T15 torx screwdriver
- Grease for screws
- Operator's Manual

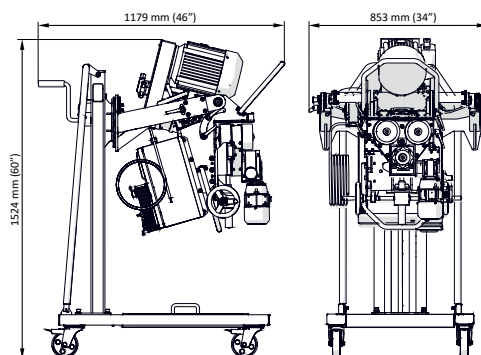

Accessories

- 
 Milling head
 (8 cutting inserts required)
 Product code: GLW-00053
- 
 Cutting insert 1 piece
 (8 required, sold 10 per box)
 Product code: PLY-000282
- 
 Cutting insert HD for all material grades incl. hard metals 1 piece
 (sold 10 pcs/box)
 Product code: PLY-000591
- 
 Insert screw for cutting insert
 Product code: SRB-000485



ABM-50 DD Vario

ABM-50 DD

AUTO-FEED HEAVY DUTY BEVELLER

The ABM-50 DD Vario is a self-propelled beveling machine that produces high quality bevels up to 50 mm wide, on the top edge of plates from 8 mm to 80 mm thick, without thermal distortion or the creation of a heat-affected zone through efficient milling using a high speed rotary head with cutting inserts.

Adjustment of spindle speed and feed rate, together with a load level LED monitoring system, helps to optimize cutting conditions depending on the grade of material, including stainless steel, duplex, alloys, hardox and many others.

The ABM-50 DD Vario allows continuous adjustment of bevel angle over a wide range from 15 to 70 degrees. For beveling carbon steel only, the customer can choose the basic ABM-50 DD model with fixed spindle speed.

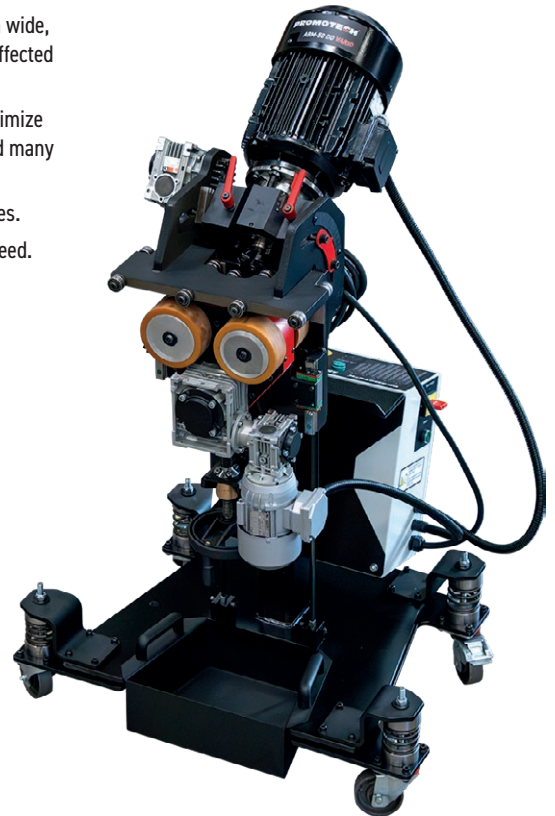

Features & benefits:

- Self-propelled machine moves along the edge of the plate at speeds of up to 1.2 m/min.
- Auto-feed machining to increase ergonomics, comfort, and productivity
- Continuous bevel angle adjustment from 15° to 70°
- High-quality bevels made without thermal distortion or creation of heat-affected zone on plate thickness range 8-80 mm
- Continuous bevel width adjustment up to 50 mm at 45 degrees
- Variable spindle speed for machining a wide range of steel grades
- LED monitoring system indicates the load level by means of green, yellow and red signals to prevent motor damage
- Top beveling with height adjustment between 840 and 1040 mm from the floor
- Milling head equipped with 5 pcs of 4-sided indexable cutting inserts
- A range of cutting inserts designed for optimum performance on a variety of materials
- Stationary operation for machining small workpieces

TECHNICAL SPECIFICATION	ABM-50 DD Vario	ABM-50 DD *
Voltage	3~ 400 V + PE, 50/60 Hz 3~ 480 V + PE, 50/60 Hz	3~ 400 V + PE, 50/60 Hz 3~ 480 V + PE, 50/60 Hz
Power	4 kW	4 kW
Spindle rotational speed (without load)	500-1450 rpm	1450 rpm (50 Hz) 1750 rpm (60 Hz)
Feed speed	0-1.2 m/min (0-3.94 ft/min)	0-1.2 m/min (0-3.94 ft/min)
Bevel angle (β, Fig. 1)	15-70°	15-70°
Maximum bevel width (b, Fig. 1)	50 mm (2")	50 mm (2")
Maximum milling head penetration ('d', Fig. 1) per single pass	6 mm (15/64")	6 mm (15/64")
Sheet thickness	8-80 mm (5/16-3 9/64")	8-80 mm (5/16-3 9/64")
Required ambient temperature	0-40°C (32-104°F)	0-40°C (32-104°F)
Weight	260 kg (573 lbs)	260 kg (573 lbs)
Product code (packed in cardboard):	UKS-0773-10-40-01-0	UKS-0773-10-40-02-0
Product code (packed in wooden case):	UKS-0773-10-40-03-0	UKS-0773-10-40-00-0

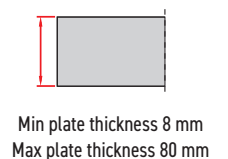
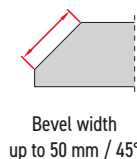
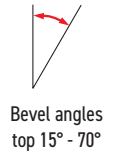
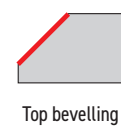

* Model ABM-50 DD features constant spindle speed



β	b
15°	41.8 mm (1 41/64")
30°	46.2 mm (1 13/16")
45°	50.2 mm (1 31/32")
60°	46 mm (1 51/64")

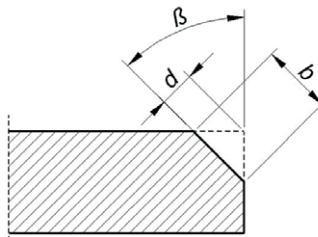

Accessories:

- GLW-0773-28-00-00-0 Milling head (with fixing screws, 5 inserts required)
- PLY-000591 Cutting insert /heavy duty/ 1 piece (sold 10 pcs/box)
- PLY-000781 Cermet cutting insert for steel 1 piece (sold 10 pcs/box)
- PLY-000835 Cutting insert for stainless steel 1 piece (sold 10 pcs/box)
- SRB-000485 Mounting screw for cutting insert
- SMR-000005 Grease for screws (5 g/0.17 oz)
- FLT-000026 Control cabinet filter 92x92 mm (sold 5 pcs/set)



GLW-0773-28-00-00-0



PLY-000835



PLY-000591



PLY-000781



SMR-000005



FLT-000026



SRB-000485

Standard shipping set:

- Beveller incl. milling head and 5 cutting inserts
- Box with base and mounting brackets
- 22 mm combination wrench
- 8 mm hex T-wrench with ball end
- T15 Torx screwdriver
- Grease for screws (5 g/0.17 oz)
- Special wrench
- Operator's Manual

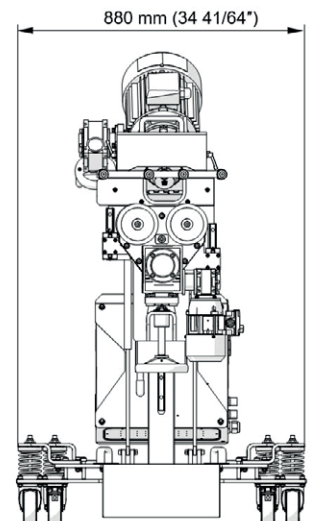
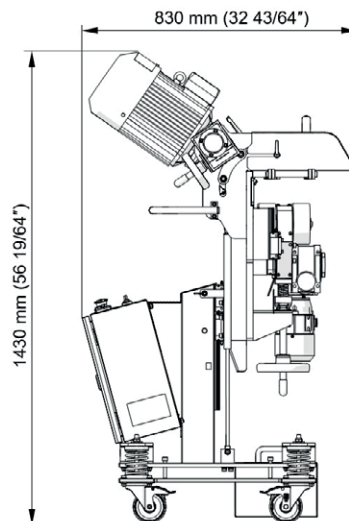



PRO-2 PB | COMPACT PIPE BEVELLER

PRO-2 PB is a compact, handy pipe beveler that mills pipes made of carbon and stainless steel, aluminum alloys, and copper-nickels. The machine can face off and bevel pipes from inner diameters (ID) of 19.5 mm (0.77") to outer diameters (OD) of 48 mm (1.89").

Small pipes from ID 15.5 mm (0.61") up to OD 29 mm (1.14") can be beveled with optional small mandrel set.

PRO-2 PB is able to mill also larger pipes from ID 38 mm (1.50") up to OD 60.3 mm (2.37") by means of an optional extension set.

Its exceptionally narrow housing (only 48 mm wide) makes it perfectly suited to space restricted areas such as boiler water walls.

PRO-2 PB incorporates overload systems incl. wet multi-disk friction clutch to prevent gear damage if the tool gets stuck.



Standard shipping set:

- Beveling machine (without motor, tool bits)
- Plastic box
- Standard self-centering expandable mandrel for pipe ID \varnothing 19.5 - 38 mm (0.77-1.50")
- 4 sets of spreaders and 4 expansion sleeves for standard mandrel
- Tool bit holder
- Handle
- Set of tools
- Tool box
- Coolant container with nozzle
- Operator's manual



Product Code: UKS-0731-10-00-00-0



TECHNICAL SPECIFICATION	PRO 2 PB with air motor	PRO 2 PB with electric motor	PRO 2 PB with battery motor
Air requirement	0.6 MPa (87 psi)	-	-
Air consumption	1600 l/min (56.5 CFM)	-	-
Voltage	-	1 ~ 220-240 V, 50-60 Hz	18 V DC
Power	800 W	1100 W	-
Connection	CEJN 410 DN 10.4 R 1/2" BSPT fitting for quick-coupling	Electrical plug	Battery connection
Nominal rotational speed	105 rpm	10-134 rpm (gear 1) 30-377 rpm (gear 2)	10-60 rpm (gear 1) 30-205 rpm (gear 2)
Pipe diameter		19.5 mm ID-48 mm OD 15.5 mm ID-29 mm OD* 38 mm ID-60.3 mm OD**	
Maximum pipe wall thickness	8 mm 3.5 mm*	8 mm 3.5 mm*	8 mm 3.5 mm*
Weight with motor	7.6 kg (17 lbs)	7.4 kg (16.5 lbs)	6.5 kg (14.5 lbs), includes battery



Max wall thickness up to 8 mm (0.32")



ID 19.5 - 38 mm (0.77 - 1.50")
ID 15.5 - 22 mm (0.61 - 0.87") /option/
ID 38 - 58 mm (1.50 - 2.28") /option/



Facing off



Pipe OD beveling up to 48 mm (1.89") up to 60.3 mm (2.37") /option/

* With an optional small mandrel set (ZST-0731-03-00-00-0).

** With an optional extension set (ZST-0731-02-00-00-0).

3 different sources of power to choose from:

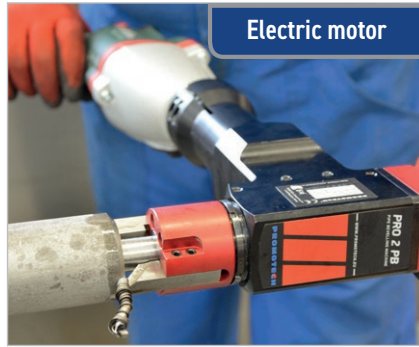

Optional accessories:



Tool bits:

NOZ-000071 for steel	0° facing tool bit short	
NOZ-000078 for stainless steel	0° facing tool bit short*	
NOZ-000072 for steel	0° facing tool bit long	
NOZ-000079 for stainless steel	0° facing tool bit long*	
NOZ-000073 for steel	30° bevelling tool bit	
NOZ-000080 for stainless steel	30° bevelling tool bit*	
NOZ-000074 for steel	37.5° bevelling tool bit	
NOZ-000081 for stainless steel	37.5° bevelling tool bit*	
NOZ-000075 for steel	45° bevelling tool bit	
NOZ-000082 for stainless steel	45° bevelling tool bit*	



Small mandrel set for pipes from
ID 15.5 mm (0.61") up to OD 29 mm (1.14")
Product Code: ZST-0731-03-00-00-0

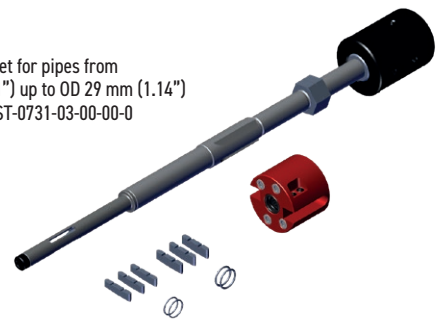

Extension set for pipes from
ID 38 mm (1.50") up to OD 60.3 mm (2.37")
Product Code: ZST-0731-02-00-00-0

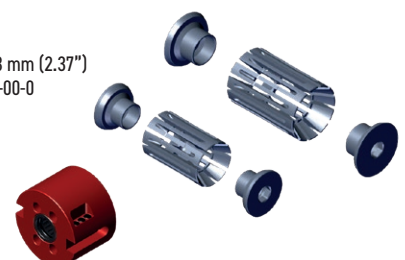

* Tool bits for stainless steel feature TiAlN coating



PRO-5 PB | PORTABLE PIPE BEVELLER



PRO-5 PB is a handy, portable pipe beveling machine suitable for milling edges of pipes made of carbon and stainless steels, aluminum alloys and copper-nickels.

It can be used efficiently by a single operator. Self-centering expandable mandrels provide quick and proper alignment to a pipe or a tube prior to machining operations.

Depending on the tool bits in use PRO-5 PB can perform external beveling, J-beveling, internal calibration and facing pipes from inside diameters of 32 mm (1.26") to outside diameters of 114 mm (4.49") or up to 140 mm (5.51") as option. All these weld prep operations are made fast and easy. Up to three tool bits can be mounted and work, simultaneously.

According to users preferences and depending on site conditions PRO-5 PB machine can be operated with a high quality powerful pneumatic motor, top quality high torque electric motor or battery drive.

Optional small spindle disc and ratchet wrench enable pipe machining in difficult to access and space restricted areas.

Standard shipping set:

- PRO-5 PB (without motor, tool bits)
- Plastic box
- Standard self-centering expandable mandrel for pipe ID \varnothing 32 - 107 mm (1.26 - 4.21")
- 118 mm spindle disc
- Jaw blocks (1,2,3,4,5,6) - 3 sets
- Set of tools
- Coolant container
- Operator's Manual

Product Code: UKS-0472-10-00-00-0



Technical specifications		PRO-5 PB with electric motor	PRO 5-PB with pneumatic motor	PRO 5-PB with battery motor
Electric motor		1.100 W	-	-
Voltage		1- 110-120 V, 50-60 Hz 1- 220-240 V, 50-60 Hz	-	18 V DC
Rotational speed (nominal)		0-113 rpm (gear 1) 0-318 rpm (gear 2)	90 rpm	-
Pneumatic drive		-	800 W	-
Air requirement		-	0,6 MPa (87 PSI)	-
Air consumption		-	1400 l/min (50 CFM)	-
Pipe diameter		32 mm ID to 114 mm OD (1.26-4.49") ID 25-32 mm (1" - 1.25") /option/ ID 107-133mm (4.21" - 5.24") /option/		
Maximum pipe wall thickness for outside diameter	up to 114 mm	12 mm (0.47")	12 mm (0.47")	12 mm (0.47")
	114-124 mm*	10 mm (0.39")	10 mm (0.39")	10 mm (0.39")
	124-132 mm*	8 mm (0.31")	8 mm (0.31")	8 mm (0.31")
	132-140 mm*	6 mm (0.24")	6 mm (0.24")	6 mm (0.24")
Weight (incl. motor)		11 kg (24 lbs)	10 kg (22 lbs)	10 kg (22 lbs) includes battery

* Available with the optional 140 mm spindle disk set.

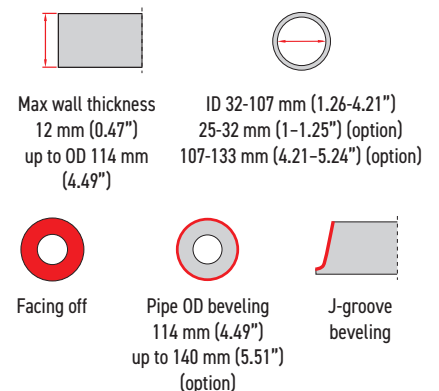

Optional accessories:

Electric motor 230V with connection set



Electric motor 230V
Product Code: SLN-000238

Connection set for electric motor
Product Code: ZST-0472-99-00-00

Pneumatic motor
Product Code:
NPD-0472-03-00-00-0



Connection set for battery drive
Product Code: ZST-0472-22-00-00-0



Battery brushless drive
Product Code: WRT-000024



Small mandrel
ID 25 - 32 mm (1" - 1-1/4")
Product Code: TRZ-0472-21-00-00-0



Battery 4.0 Ah
AKM-0738-10-00-01-0



Battery 5.5 Ah
AKM-0738-10-00-03-0



Battery 10.0 Ah
AKM-0738-10-00-02-0



Battery charger with built-in Air-Cooled system
LDW-0738-10-00-30-0 (EU)
LDW-0738-04-00-30-0 (UK)

Charging time: ~ 30 min (4.0 Ah)
~ 41 min (5.5 Ah)
~ 74 min (10.0 Ah)

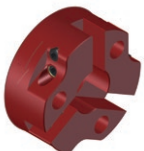
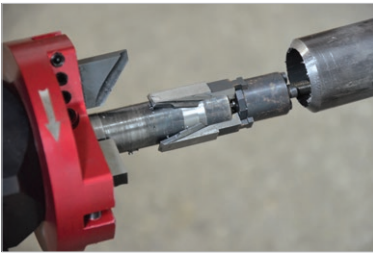

75 mm spindle disc
Product Code:
TRC-0472-12-00-00-0



Ratchet wrench
Product Code: KLC-000045



Minimum distance between
tubes is 75 mm (2.95")

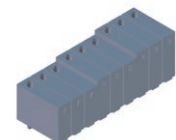
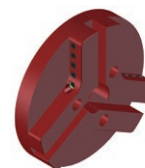

Extension set for OD Ø up to 140 mm (5.51") including 140 mm spindle disc and jaw blocks (7, 8, 9) - 3 sets
Product Code: ZST-0472-15-00-00-0

NOZ-000031 for steel NOZ-000067 for stainless steel	F0-30 0° facing tool bit	
NOZ-000032 for steel NOZ-000034 for stainless steel	B30 30° bevelling tool bit*	
NOZ-000033 for steel NOZ-000035 for stainless steel	B30d 30° bevelling tool bit**	
NOZ-000036 for steel NOZ-000038 for stainless steel	B375 37.5° bevelling tool bit*	
NOZ-000037 for steel NOZ-000039 for stainless steel	B375d 37.5° bevelling tool bit**	
NOZ-000040 for steel	B45 45° bevelling tool bit*	
NOZ-000041 for steel	B45d 45° bevelling tool bit**	

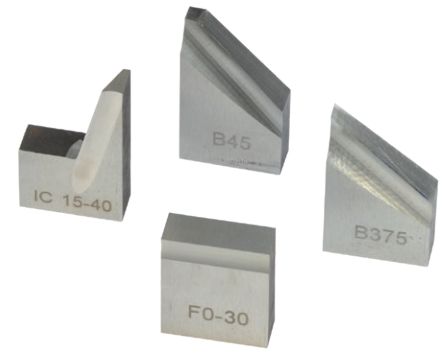

Wide range of tool bits for various applications.

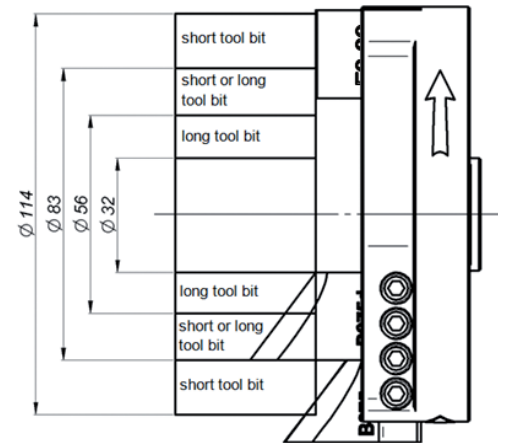

Together with 0° facing tool bit either standard or long bevelling tool bits are in use depending on pipe diameter

Tool bits for stainless steel feature TiAlN coating

* for diameters over 56 mm, if works together with 0° facing tool bit

** for diameters under 83mm, if works together with 0° facing tool bit

NOZ-000052 for steel	IC15-40 15° internal calibration tool bit	
NOZ-000053 for steel	IC15-40 15° internal calibration tool bit (for Φ over 56 mm)	
NOZ-000087 for steel	IB12-60 12° internal bevelling	
NOZ-000058 for steel	J10-R6 10° J-bevelling tool bit	
NOZ-000057 for steel	J15-R2 15° J-bevelling tool bit	
NOZ-000059 for steel	J20-R8 20° J-bevelling tool bit	
NOZ-000088 for steel	J20-R1 20° J-bevelling tool bit	



Stainless steel machining is available by means of special tool bits



HD-CUT OIL 1 - tapping, drilling and machining fluid product codes:
OLJ-0505-09-00-00 (0.5 kg)
OLJ-0505-10-00-00 (1.0 kg)
OLJ-0505-11-00-00 (5.0 kg)



Air preparation set
Product Code:
ZST-000021

PRO-10 PB | PORTABLE PIPE BEVELER & FLANGE FACER



PRO-10 PB is a heavy-duty ID mounted pipe beveller utilizing self-centering expandable mandrels to provide quick and proper alignment to a pipe or a tube prior to machining operations.

The beveller is capable of milling the OD bevel, root face and ID counterbore to create a uniform wall thickness around the joint and ensure full weld penetration.

Optional accessories extend the possible applications of the PRO-10 PB to include flange facing and oval beveling.



Features and benefits:

- Can be mounted in pipe or tubing with a minimum inside diameter of 38 mm (1.5") and bevel outside diameters up to 355 mm (14")
- Available with a powerful pneumatic motor or a high-torque electric motor
- spindle disc with two tool bit holders for more stable, less stress-sensitive operation of tool bits
- Standard and custom made tool bits available
- J-bevel tool bits available for high welding efficiency on thicker walled pipe
- Self-centering expandable ID mounted mandrels enable highly repeatable and consistent fit-up and can be rapidly deployed from one pipe to another to reduce cycle times and improve workflow
- It can be used efficiently by a single operator

Standard shipping set:

- PRO-10 PB (without motor, tool bits)
- Metal box
- Standard self-centering expandable mandrel for pipe ID \varnothing 84 - 269 mm (3.31 - 10.59")
- Jaw blocks (1,2,3,4,5,6) and adapter - 3 sets
- Set of tools
- Coolant container
- Operator's manual

Product code: UKS-0807-10-00-00

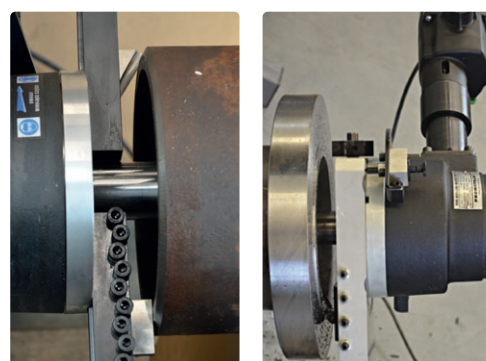

Technical specifications	PRO-10 PB with electric motor	PRO-10 PB with pneumatic motor
Electric motor	1.8 kW	-
Supply	110-120 V / 50-60 Hz or 220-240 V / 50-60 Hz	-
Rotational speed (nominal)	gear 1-12 to 29 rpm gear 2-41 to 96 rpm	-
Pneumatic drive	-	1,8 kW
Air requirement	-	0,6 MPa
Air consumption	-	1750 NL/min
Rotational speed (without load)	-	17 rpm
Rotational speed (nominal)	-	9 rpm
Min ID	84 mm (3.31"); 38 mm - option	84mm (3.31"); 38mm - option
Max ID	269 mm (10.59"); 349 mm (13.74") - option	269 mm (10.59"); 349 mm (13.74") - option
Max OD	273 mm (10.75"); 355 mm (13.98") - option	273 mm (10.75"); 355 mm (13.98") - option
Max. wall thickness	15 mm (0.59")	15 mm (0.59")
Weight (incl. motor)	38 kg (84 lbs)	35 kg (77 lbs)

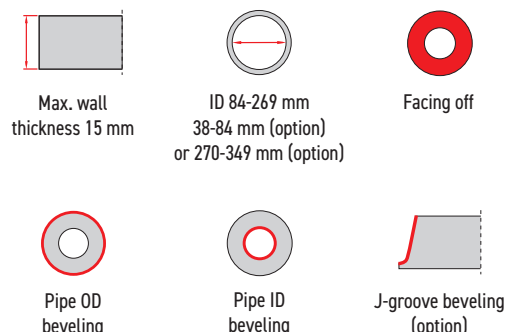

Optional accessories:



Pneumatic motor
Product Code: SLN-0200-15-00-00-0



Electric motor 230 V
Product Code: SLN-000094

Electric motor 115 V US plug
Product Code: SLN-000102

Electric motor 115 V UK plug
Product Code: SLN-000120



Connection set for electric motor
Product Code: ZST-0200-99-01-00-0

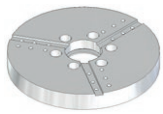

Spindle disc suitable for three tool bit holders
Product code: TRC-0807-05-00-00-0

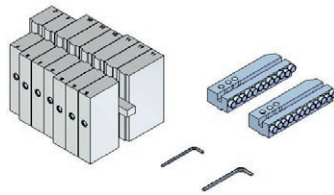

Extension set for OD ϕ up to 355 mm (14")
incl. 2 extended tool bit holders and jaws 7, 8, 9, 10, 11
Recommended for pipe wall thickness up to 7 mm (0.26")
Product Code: ZST-0807-08-00-00-0

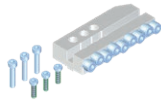

Regular tool bit holder ID 84-269 mm max OD up to 273 mm
Product code: OBS-0807-99-01-00-0

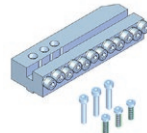

Extended tool bit holder max OD up to 355 mm
Product code: OBS-0807-99-02-00-0



Air preparation set
Product Code: ZST-000021



Small expanding mandrel set incl. jaws I, II, III, IV for pipe ID ϕ 38 - 86 mm (1.5 to 3.39")
Product Code: ZSP-0200-05-00-00-2



Large expanding mandrel for pipe ID ϕ 126 - 296 mm (5 to 11.65") with standard jaws, and pipe ID ϕ 219 - 376 mm (8.62 to 14.80") with optional extension set
Product Code: TRZ-0807-99-00-00-0

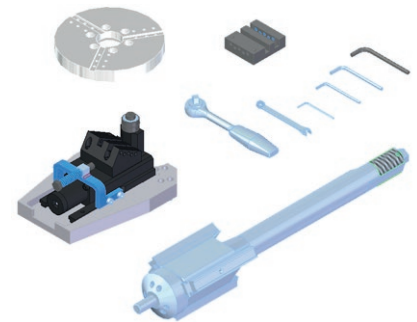

Oval attachment set incl. large mandrel for pipe ID ϕ 126 - 296 mm (5 to 11-5/8") and spindle disc for three tool bits holders
Product Code: PRK-0807-07-00-00-0

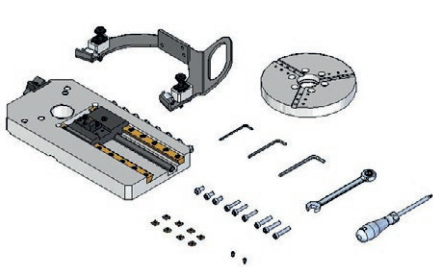

Flange facing attachment incl. spindle disc for three tool bits holders
Product Code: PRK-0807-06-00-00-0

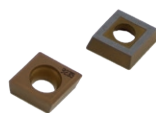

Flange facing insert
Product Code: PLY-000533



Flange facing insert fixing screw (suitable for cutting inserts PLY-000533)
Product Code: SRB-000465

Flange diameter	90-508 mm (3.54-20")
Automatic feed range	180.5 mm (7.11")
Diameter of rotating parts	569.4 mm (22.42")
Pipe ID	84-269 mm (3.31-10.59") using the standard expanding mandrel 219-376 mm (8.62-13.74") using the large expanding mandrel and jaws from extension set
Feed per rotation	0.33 mm (0.013", with one tripper block engaged) 0.66 mm (0.026", with two tripper blocks engaged)

Standard and custom made tool bits:

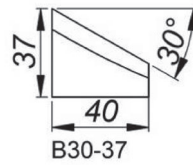
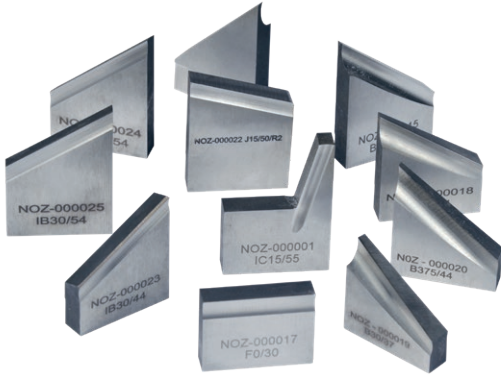

30° Beveling Tool Bit,
Height 37 mm [B30/37]
Product Code: NOZ-000019

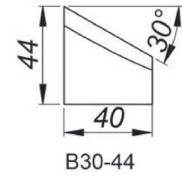

30° Beveling Tool Bit,
Height 44 mm [B30/44]
Product Code: NOZ-000018

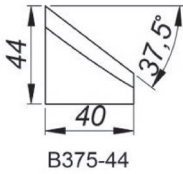

37.5° Beveling Tool Bit,
Height 44 mm [B375/44]
Product Code: NOZ-000020

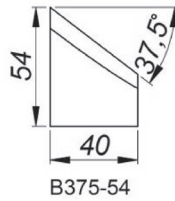

37.5° Beveling Tool Bit,
Height 54 mm [B375/54]
Product Code: NOZ-000015

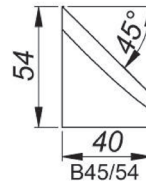

45° Beveling Tool Bit,
Height 54 mm [B45/54]
Product Code: NOZ-000021

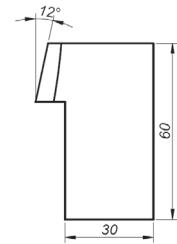

12° Special Tool Bit
Height 60 mm
Product Code: NOZ-000086

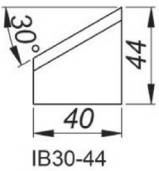

30° Internal Beveling Tool Bit,
Height 44 mm [IB30/44]
Product Code: NOZ-000023

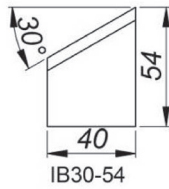

30° Internal Beveling Tool Bit,
Height 54 mm [IB30/54]
Product Code: NOZ-000025

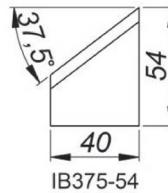

37.5° Internal Beveling Tool Bit,
Height 54 mm [IB375/54]
Product Code: NOZ-000024

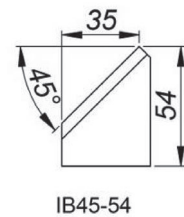

45° Internal Beveling Tool Bit,
Height 54 mm [IB45/54]
Product Code: NOZ-000026

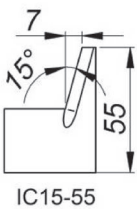

15° Internal Calibration Tool Bit,
Height 55 mm [IC15/55]
Product Code: NOZ-000001

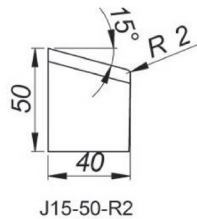

15° J-Beveling Tool Bit,
Height 50 mm, Radius 2 mm [J15/50/R2]
Product Code: NOZ-000022

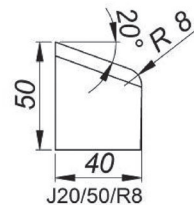

20° J-Beveling Tool Bit,
Height 50 mm, Radius 8 mm [J20/50/R8]
Product Code: NOZ-000016

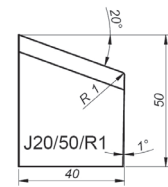

20° J-Beveling Tool Bit,
Height 50 mm, Radius 1 mm [J20/50/R1]
Product Code: NOZ-000085

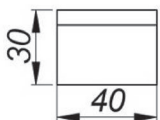

F0-30

Facing Tool Bit,
Height 30 mm [F0/30]
Product Code: NOZ-000017

Custom made versions of tool bits are available on request.
Tool bits could also be coated to increase their durability.



PRO-40 PBS | PIPE BEVELLING MACHINE

PRO 40 PBS is designed for beveling and facing pipes, tanks or tubes in a range of diameters from 200 mm to 1000 mm (8-40"). High-speed rotary milling head with replaceable inserts enables effective and efficient machining with bevel widths up to 45 mm (1-3/4") and angles between 0° and 60°. Internal beveling and J-groove end preparation is optionally available.



Stainless Steels
machining is now possible.



Use of heavy duty milling head in PRO 40 PBS offers accurate bevels in a fraction of the time compared to traditional single point machining. This feature saves time and money by excellent efficiency.

Standard shipping set:

- Stationary pipe beveling machine
- Active support (with plastic rollers)
- Passive support (with steel rollers)
- Standard milling head with 7 cutting inserts
- Set of guiding chains
- 10 mm hex wrench
- 8 mm hex wrench
- 5 mm hex wrench
- Torx T15P screwdriver
- Operator's manual
- Wooden box



User-friendly control panel

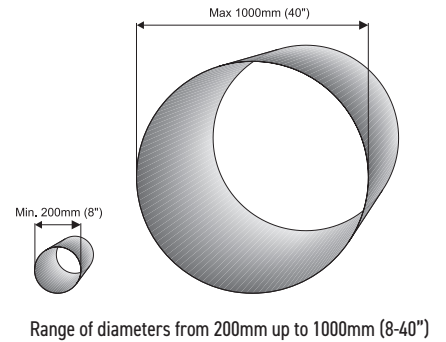

PRO-40 PBS Technical specification	
Power supply	1~ 208 - 230 V, 50/60 Hz 3~ 208 - 230 V, 50/60 Hz
External pipe diameter range	200-1000 mm (8" - 40") pipes longer than 830 mm; 200-600 mm (8" - 23-5/8") pipes of 400-830 mm length
Maximum allowed pipe weight	10 000 kg (22 000 lbs)*, if active support equipped with optional steel rollers
Min. pipe wall thickness	5 mm (3/16")
Pipe fixing	mechanical with chain
Feed rate	100-1100 mm/min
Beveling angle range	0-60° with continuous angle adjustment
Max OD bevel width	45 mm (1-3/4")
Max ID bevel width	5 mm (1/4") standard, up to 20 mm ("13/16) - option
Beveling type „J”	YES - option
„J” type beveling radius	0.24 in./6 mm or 0.31 in./8 mm
Product Code	UKS-0436-10-20-00-1

* 6000 kg (13 200 lbs) for plastic rollers of active support (standard)

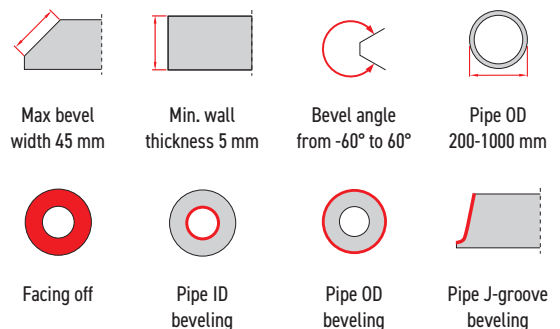
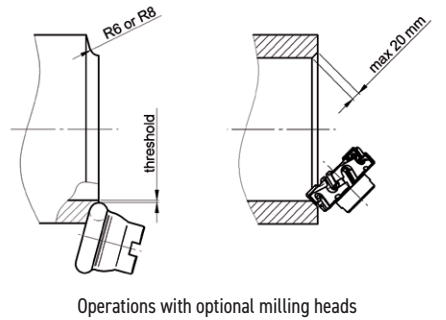

■ **Beveling – standard accessories**



GLW-000013
Standard Milling head
(7 inserts required)

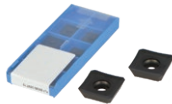

PLY-000282
Cutting inserts for beveling
1pc (sold 10pcs/box)



PLY-000591
Cutting insert HD for beveling
1pc (sold 10pcs/box)



SRB-000311
Insert fixing screw for
PLY-000282, PLY-000591,
PLY-000781, PLY-000835



PLY-000781
Cermet cutting insert for steel
1pc (sold 10pcs/box)



PLY-000835
Cutting insert for stainless steel
1pc (sold 10pcs/box)

■ **Internal Beveling – option**



GLW-0436-19-00-00-0
Milling head for internal
beveling

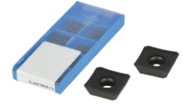

PLY-000282
Cutting inserts for beveling
1pc (sold 10pcs/box)



SRB-000311
Insert fixing screw for
PLY-000282

■ **J-Groove Beveling - option**



GLW-0518-07-03-00-0
J-groove R6 milling head
(6 inserts R6 required)



PLY-000422
Cutting insert for J groove R6 end
preparation 1pc (sold 10pcs/box)



SRB-000297
Insert fixing screw for
PLY-000422



GLW-0518-07-04-00-0
J-groove R8 milling head
(5 inserts R8 required)



PLY-000424
Cutting insert for J groove R8 end
preparation 1pc (sold 10pcs/box)



SRB-000367
Insert fixing screw for
PLY-000424

■ **Beveling of short pipes – option**



DCS-0436-99-00-00-0
Clamping device for short pipes
of 400-830 mm length

■ **Beveling of oval pipes – option**

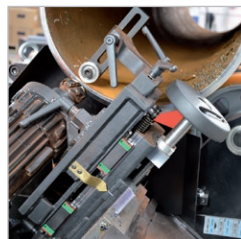

WSP-0436-24-00-00-0
Oval pipe tracking attachment (enables
consistent land/root face thickness)
Available either with brand new machine
or for retrofitting

■ **Beveling pipes up to 10 tons -option**

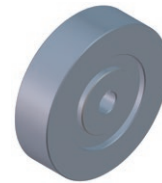

KOL-0436-23-00-00-0
Steel roll for active pipe
support 1pc (4pcs required)

■ **Stainless Steels Beveling - option**



LNC-0436-25-01-00-0
Set of guiding chains
for Stainless Steel



DCS-0436-25-10-00-0
Clamping device for short
Stainless Steel pipes

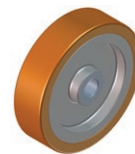

KOL-000077
Wheel with Vulkollan tire
1pc (2 pcs needed)



RLK-0436-25-11-00-0
Stainless Steel roll for
oval pipe tracking attachment

■ **Features and benefits**



Shields and internal lighting increase safety
and comfort of the operator



Adjustable chain
(Ø 200-1000 mm) ensures
positive axial rotation

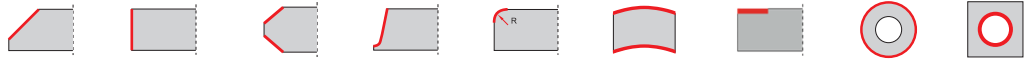

Heavy-duty adjustable pipe
support (Ø 200-1000 mm)

PLATE BEVELLERS FAMILY

	SINGLE	FACE-OFF	DOUBLE	J-GROOVE	RADIUS	ROUND	CLAD	OD	COUNTER-SINKING
ABM-14	X		X					X	
ABM-29	X		X						
ABM-30	X	X	X						
ABM-50	X		X						
ABM-50 DD VARIO	X								
BM-6 Battery	X				X	X		X	X
BM-7	X				X	X		X	X
BM-18	X				X	X		X	X
BM-18A	X				X	X			X
BM-20plus	X	X				X		X	
BM-21	X	X						X	
BM-25 /BM-25S	X	X					X	X	
SBM-500	X							X	



	BEVEL ANGLES	MAX BEVEL WIDTH	PLATE THICKNESS	MOTOR TYPE
ABM-14	22.5°, 25°, 30°, 35°, 37.5° or 45°	14 mm	from 6 mm up to 40 mm	electric
ABM-29	top 20° - 45°, bottom 20° - 45°	29 mm	up to 50 mm	electric
ABM-30	- 70° to 0°; 0° to 70°	30 mm	from 8 mm up to 60 mm	electric
ABM-50	- 60° to - 15°; 15° to 60°	50 mm	from 8 mm up to 80 mm	electric
ABM-50 DD VARIO	top 15° - 70°	50 mm	from 8 mm up to 80 mm	electric
BM-6 Battery	45°, 30° (option)	6 mm	min. 2 mm	battery
BM-7	45°, 30° (option)	7 mm	min. 1.5 mm	electric
BM-18	22.5°, 30°, 37.5°, 45°, 55° or 60°	18 mm	min. 2 mm	electric
BM-18A	22.5°, 30°, 37.5°, 45°, 50°, 55° or 60°	18 mm	min. 2 mm	pneumatic
BM-20plus	15° to 60° or 0° (option)	21 mm	min. 2 mm	electric
BM-21	0° to 60°	21 mm	min. 2 mm	electric
BM-25/BM-25S	0°-90° (15°-75° recommended)	25 mm	min. 2 mm	electric
SBM-500	15° to 60°	30 mm	from 3 mm up to 100 mm	electric

PIPE BEVELLERS FAMILY

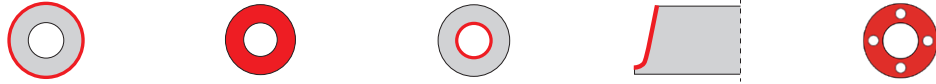

	OD BEVEL	FACE-OFF	ID BEVEL	J-GROOVE	FLANGE FACING
PRO-2 PB	X	X			
PRO-5 PB	X	X	X	X	
PRO-10 PB	X	X	X	X	X
PRO-40 PBS	X	X	X	X	

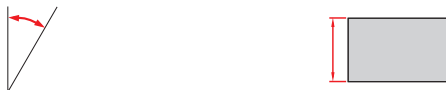

	BEVEL ANGLES	PIPE WALL THICKNESS	MOTOR TYPE
PRO-2 PB	F0°, B30°, B37.5°, B45°	up to 8 mm	electric, pneumatic, battery
PRO-5 PB	F0°, J10°, IC15°, J15°, J20°, B30°, B37.5°, B45°	up to 12 mm	electric, pneumatic, battery
PRO-10 PB	F0°, IC15°, J15°, J20°, B30°, IB30°, B37.5°, IB37.5°, B45°, IB45°	up to 15 mm	electric, pneumatic
PRO-40 PBS	0° to 60° or -60° to 0° (option)	minimum 5 mm	electric

B - bevel tool bit, F - facing tool bit, IB - internal beveling, IC - internal calibration tool bit, J - J-groove tool bit

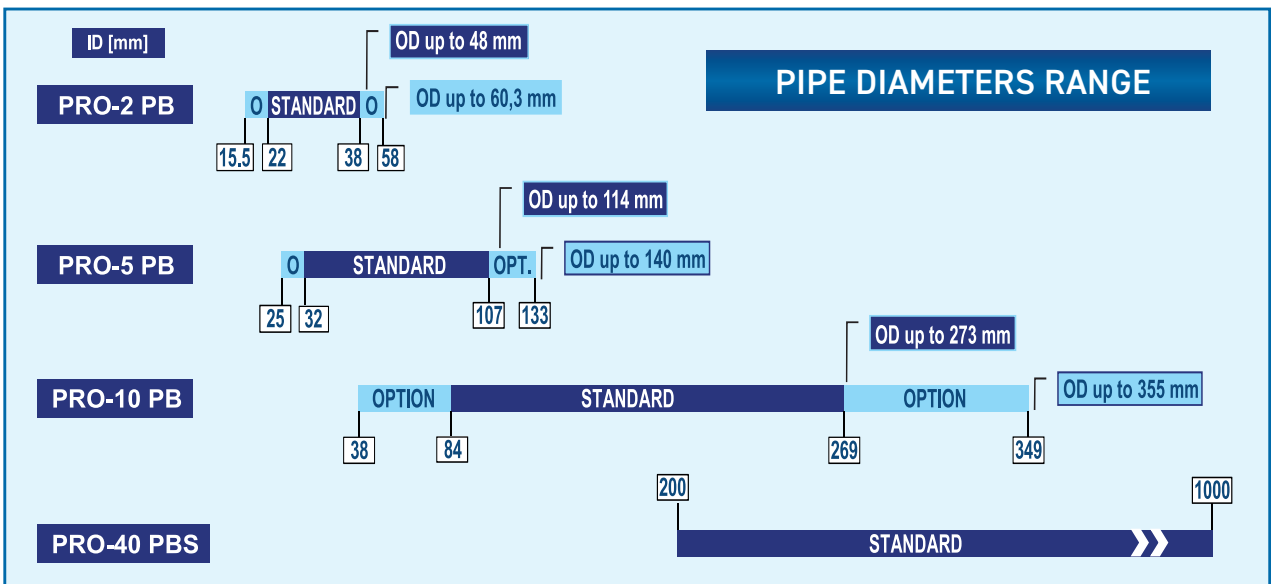



PLATE BEVELLERS



BM-6 Battery



BM-7



BM-18



BM-18A



BM-20plus



BM-21



BM-25



BM-25S



BM-30 WM



SBM-500



ABM-14



ABM-30



ABM-29



ABM-50

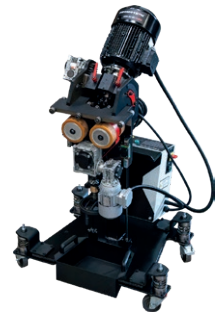

ABM-50 DD VARIO

PIPE BEVELLERS



PRO-2 PB



PRO-5 PB



PRO-10 PB



PRO-40 PBS

All information is subject to change without notice. 26.04

Stay connected



Follow us on our social media to discover how our machines and solutions can boost your industrial processes





- Expert insights
- Hands-on knowledge
- Industry trends & innovations
- Inspiring applications
- Real-world case studies
- Tips & tricks
- and more

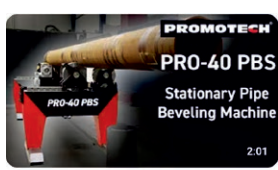
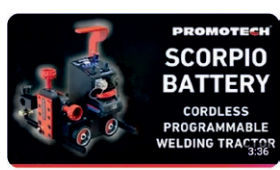

PROMOTECH International

Don't miss a thing

 <p>PRO-40 PBS Stationary Pipe Beveling Machine 2:01</p>	 <p>SCORPIO BATTERY CORDLESS PROGRAMMABLE WELDING TRACTOR 3:36</p>	 <p>ABM-50 DD VARIO AUTO-FEED HEAVY DUTY BEVELLER 1:50</p>	 <p>MCM 5-axis Portable CNC Cutting & Welding Machines 3:37</p>
<p>PRO-40 PBS Stationary Pipe Beveling Machine</p>	<p>SCORPIO BATTERY: Advanced Battery-Powered Welding Tractor</p>	<p>ABM-50 DD Vario Auto-Feed Heavy Duty Beveler</p>	<p>PROMOTECH MCM 5-Axis CNC Machine- Revolutionize Wind Tower Door Frame...</p>

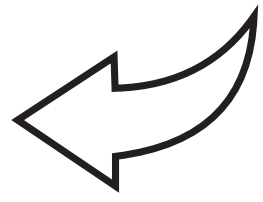

Check our **BLOG** for expert insights, practical guides and product news

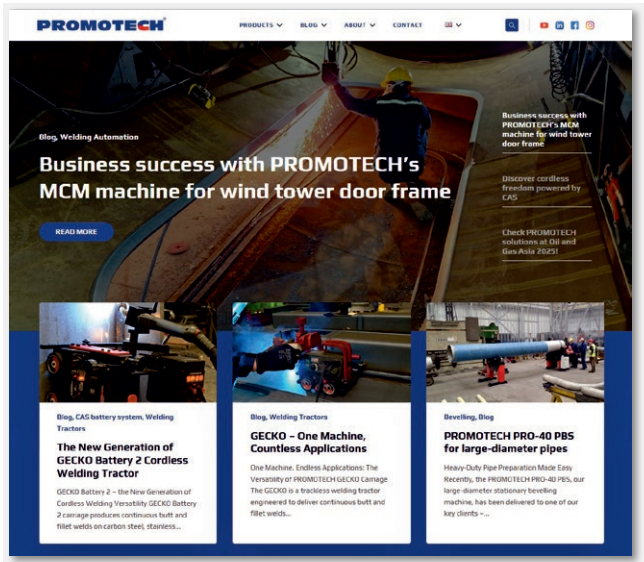

PROMOTECH[®]

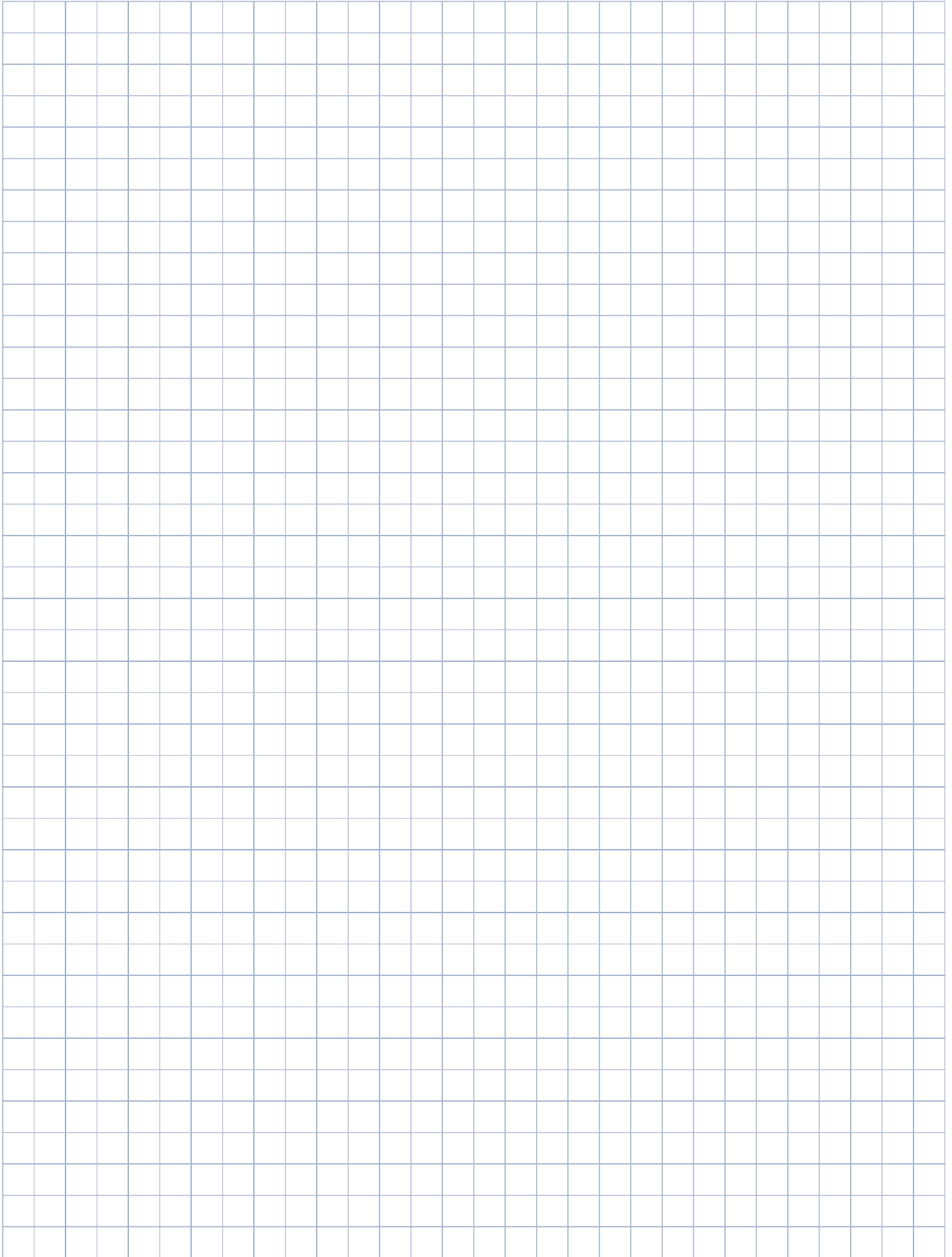

PROMOTECH Sp. z o.o.
ul. Elewatorska 23/1
15-620 Białystok
POLAND

Phone: +48 85 678 34 05
marketing@promotech.eu
www.promotech.eu

PROMOTECH DEUTSCHLAND GmbH
Riedweg 11
D-88339 Bad Waldsee/Gaisbeuren
DEUTSCHLAND

Phone: +49 7524 9700-55
dach@pdg.promotech.eu
www.promotech-deutschland.de

PROMOTECH ME (FZE)
P6-111, Saif Zone
P.O. Box. 514914
Sharjah, UAE

Phone: +9716 552 9493
akumar@pme.promotech.eu
www.promotechme.ae

PROMOTECH Fabrication Machines Pvt. Ltd.
Head Office: Plot 231, Phase-5, Sector 53
I/E HSIIDC Kundli, Sonipat
Haryana-131028, INDIA

Phone: +91 966 766 0304
info@pfm.promotech.eu
www.promotech-india.in

smart tools for heavy tasks

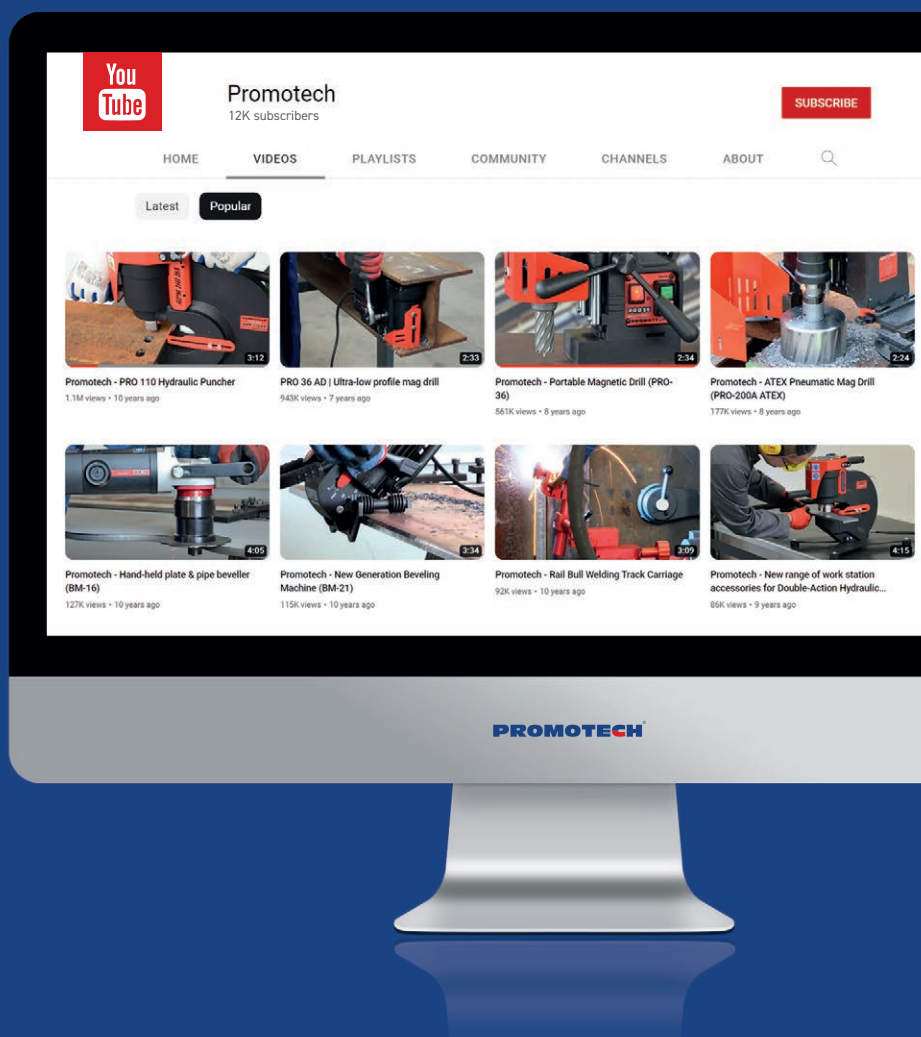

FOLLOW US FOR UPDATE AND MORE

www.promotech.eu

PROMOTECH[®]



FM 37982



Mitglied im DVS – Deutscher Verband für
Schweißen und verwandte Verfahren e. V.



American Welding Society
Supporting Company Member

Your local dealer: